

A large stage event with a DJ booth and a large screen displaying the logo 'منا سبتك YOU'RE EVENT'. The scene is dark with stage lights and a crowd in the foreground.

منا سبتك
YOU'RE EVENT®

www.yourentarabia.com

Promotional
Gift Collection

#! # \$

1 DESIGN INNOVATION
Exclusive Designs are done by competitive and well-experienced designers in house in Dubai.



OUR IN HOUSE BRANDING AND DESIGN PROCESS

2 Well-trained staff and excellent customer service team will be assisting you throughout the process.



3 DESIGN PRODUCTION
Designs are then sent to factory and mould are exclusively made for production. Samples produced and send back to HQ for testing phase and verification. Once approved, full production will take place.



4 BRANDING PRODUCTION
With the latest branding machines and technology, clients can brand their logos on the items 24/7 in house.



5 Products are shipped to our warehouse to ensure faster delivery to the clients.





BAGS

Page 6-39



OFFICE AND BUSINESS

Page 40-101

TABLE OF CONTENTS



SUSTAINABLE

Page 102-129



DRINKWARE

Page 130-157

TECHNOLOGY

Page 158-215



WRITING

Page 216-247



TABLE OF CONTENTS

GIFT SETS

Page 248-279



YOUR CHOICE

Page 280-295

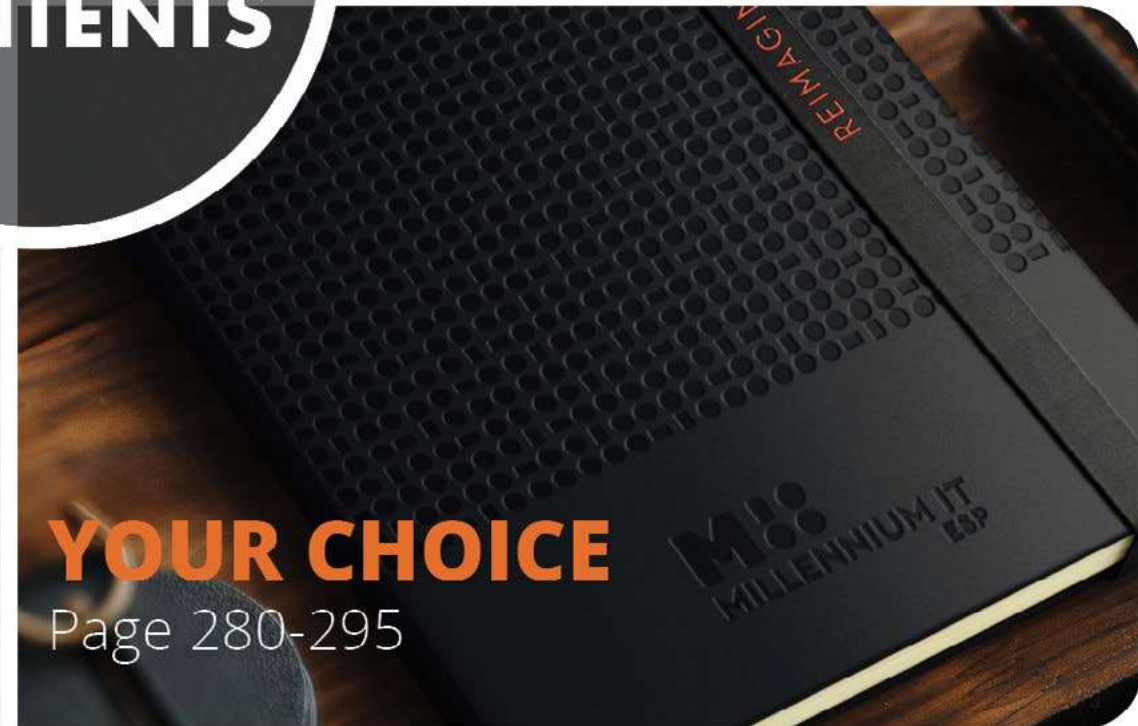



BAGS



01 BAGS

08	14	BACKPACK
15	21	TRAVEL BAG
22	27	COMPUTER BAG
28	35	POUCH
37	39	SHOPPING BAG



ELITE BAG





HOW IT WORKS

ELITE BAG

E3196

Slim Fit three dimensional ergonomic design commuter backpack which can carry up to 15.6" laptop and has pocket for 11" tablet is a splash water resistant, light weight, professional storage, smart space saving and keeps shapes at all time. Stable, Shockproof bag with retractable rubber band to help firmly secure different size and and thickness of the laptop. Pluggable with trunk and has nail reinforcement handle to ensure handle durability. Has a fast charging 3rd generation USB. Product Size: 28x16x48cm. Packaging: Special Polybag





BUSINESS PRO

E3197

Concise design business backpack which can hold up to 15.4" size laptop with quick access, simple appearance and suitable for business commuting. Material is water repellent and wear resistant polyester fabric. Adjustable shoulder strap, ergonomic design and convenient. Product Size: 42x29x10cm. Packaging: Special Polybag.





RFID BACKPACK

E3106

High Quality Laptop Backpack suits 15.6" Laptop and Tablet PC Case, U Disk, USB Port and RFID Protection. Material: High Quality Nylon + Micro Fiber High Quality Fabric. Has backside trolley strip and water bottle pocket holder. Can hold many cables, earphones, business/bank cards, pens and other accessories. Convenient for work and travelling. Quality backpack matches all fashion.

Product Size:29.5x13x39cm Packaging: High Quality Polybag





TRAVEL-PRO BACKPACK

E3090

A Multi-functional Backpack suitable for 15.6" Laptop and Tablet case. A high quality 853 Jacquard Nylon + all waterproof high quality zipper. The backside trolley strip has an anti-theft function. Consider the many pockets making the bag very convenient for working and travelling. It also has headphone port and can hold many cards, earphone, business/bank cards, pen and other accessories. Handle is Neoprene creating stronger and thicker handle. Product Size:31x13x42cm Packaging: Polybag

CASUAL BACKPACK E3107

Casual High Quality Backpack that suits 15.6" Laptop. Material is Snow Nylon. Fashionable and very light Style, with Large Capacity. Product Size: 29.5x14x42cm Packaging: High Quality Polybag





CLASSY TRAVEL

E3088

An Extensive Bag best choice for travelling because of the spacious bag design, and has magnetic pocket on front. Generally, made of Gray twill poly fabric, Trim: Black PU, Lining: Black 190T, Zipper: Nylon, Puller: Matte black metal puller, Hardware: Gun metal, Shoulder strap: Black poly webbing. Product Size: 45x20x27cm Packaging: Polybag



PASSPORT

LOGO

大陆居民

PASSPORT

THE BOARDING GATE WILL CLOSE 15 MINUTES BEFORE DEPARTURE



TRAVEL MATE

E3188

All in one place RFID safe polyester travel organizer which can be used as shoulder or wrist bag that will help you keep your important belongings in place. It is made of double layer waterproof and shockproof fabric material, well padded flexible covers and high quality zippers ensuring the protection of your valuables. Two layers in Slim design with big capacity for cards, Coins, cash, passport, tickets, accessories, mobile phone, and etc. Product Size: 24x13x5cm. Packaging: White Paper Box.







CROSSBODY BAG

E3191

Cross Body in a Camouflage pattern, fashionable and leisure style made from water resistant nylon fabric material. Product Size: 28x20x6cm. Packaging: Special Polybag .





HOW IT WORKS

TABLET SHOULDER

E3190

Tablet and Slim Laptop Bag which can cater up to 12.9" size. Front compartment with Multi-Pockets to organize digital gadgets, cables and other accessories. Material is water resistant Nylon Fabric with a leather handle and elastic silicon pads on the corner for better protection of the laptop and other gadgets from dropping and damaging. Product Size: 33x24x6cm. Packaging: Special Polybag

ELEGANT BUSINESS BAG

E3104

Elegant Business Bag with handle and sling to carry. Inside has a laptop pocket and one set of small pockets with Brass Metal accessories. Product Size:33x27x7cm Packaging: High Quality Polybag





LAPPY POUCH E3110

High Quality Laptop Pouch with handle and zipper closure. Material: Frosted 420D. Product Size:36x32.5cm(without handle Size) Packaging: Polybag





E31933

E31931



CITY COMMUTER

E3193

Your new daily office buddy that offers enough room to carry your office and personal tech partners and can carry up to 16" laptop is made out of high quality suit fabric polyester material with heavy duty accents, hardware, and stitching. Soft border lining adds extra protection around the edges and prevents dust. Comfortable grips to carry as a professional briefcase, attach the messenger strap or use the luggage strap for your luggage bag for maximum portability. Product Size: 39x28x2cm. Packaging: Special Polybag.



STYLISH LAPTOP BAG

E3103

Stylish Laptop Bag with handle and sling to carry. Front side has 2 hidden zipper pockets with small pen pocket on both sides. Inside has laptop pocket and zipper pocket.

Product Size:28.5x38x11cm Packaging: High Quality Polybag





BAGGY E3091

Comprehensive Laptop Handbag with numerous purposes. It can fit 14" laptop. The exterior section has a massive two pockets for easy storage, take in and pick up. Interior has a large compartment with large storage capacity making it travel friendly. Padded straps, shock pressure and carrying comfort. Lining material is soft velvet forming a comfortable and as protection to your laptop. Main material is 600D nylon + PU. Product Size: 45x19x35cm Packaging: Polybag



E31941



E319430



SALEM TRAVEL POUCH E3194

Travel Pouch with water resistant 600D polyester material, leather handle, and high quality zipper. Product Size: 22x11.5x10cm .
Packaging: White Paper Box .







E31892

E31891



COZY STORAGE

E3189

Electronics travel organizer bag which can keep your accessories neat and in order. It is made of double layer waterproof and shockproof polyester material, well padded flexible covers and high quality zippers ensuring the protection of your gadgets and accessories. Product Size: 21.9x13.5x6.7cm. Packaging: White Paper Box.



HOW IT WORKS



E31921



E31922





HOW IT WORKS

POUCH SOLO E3192

Electronics travel organizer wrist bag which can keep your accessories neat and in order. It is made of double layer waterproof and shockproof polyester material, well padded flexible covers and high quality zippers. Separate and different storage area will help you sort your accessories well. Product Size: 24x15x5cm. Packaging: White Paper Box.



WRISLET POUCH

E3125

Wrislet Pouch made in a special linen material of 600D polyester. Can be used in a daily basis to organize your necessities like wallet, mobile, keys and others. Has metal plate for branding. Product Size:22x14x2cm
Packaging: Polybag

STYLISH POUCH

E3102

Stylish Pouch with one zipper pocket and mesh pocket inside. Matte black metal puller with top waterproof zipper. Front has hidden zipper pocket. Product Size:15x24x6cm
Packaging: Polybag





E30853

E30852

CLASSY POUCH E3085

Small but Flexible Bag composed of two small mesh pockets inside, one zipped pocket on the other side and one zipped pocket as well on backside. Main material is from Gray Twill Poly Fabric while the Trim is a black PU, Lining is from Black 190T material, Zipper is Nylon, Puller is matte black metal, Hardware is gun metal. Product Size:21x10x11.5cm
Packaging: Polybag



There is environmental crisis caused by disposable bags. Litters are everywhere and sea creatures are disturbed and harmed due to plastic wastes. We need to act, otherwise, our environment will be destroyed.

BENEFITS OF USING REUSABLE BAGS

 Save Energy
1 reusable bag = 28 disposable bags



 Save Money



 Good Branding Impact
Brand supports Eco Sustainability



 Protect Wildlife



 Decrease Pollution





SHOPPY BAG

E3109

High Quality Shopping Bag with handle, double mesh design and magnetic lock. Material: 230D Twill. Product Size:38x32.5cm(without handle size) Packaging: Polybag



TOTE BAG E3108

Shopping Bag with pocket convenient for shopping and travelling. Fashion Style and Large Capacity. Material: Snow Nylon. Product Size:29.7x8.5x34.8cm - Packaging: High Quality Polybag



CANVASS BAG E3134

A 325 GSM white cotton bag with cream handle. This canvass can be sublimated. Bag Size: 34x0.5x43cm; Handle size: 59x3.3cm (Edge to Edge)



A circular graphic with a white border. Inside, there is a white icon of a pen in a holder. Below the icon are two horizontal lines. The text "OFFICE AND BUSINESS" is written in large, bold, white capital letters.



02

OFFICE & BUSINESS

16	55	MAGSAFE
56	61	SMART NOTEBOOK
62	62	WIRELESS CHARGER NOTEBOOK
63	71	A5 ORGANIZER AND NOTEBOOK
69	69	A6 NOTEBOOK
72	75	A4 PORTFOLIO AND ORGANIZER
76	84	NFC, RFID CARD HOLDER AND WALLETS
85	91	LAPTOP HOLDER AND STAND
92	97	MOUSEPAD
98	98	COASTER
99	99	KEYCHAIN
100	101	TRAVEL ACCESSORY



The Recycled Claim Standard (RCS) is international, voluntary standard with the purpose of ensuring the reliability of recycled content claims in products. It proves the presence and amount of recycled material in the final product through a third-party verification of the input and chain of custody which meets the ISO definitions of recycling.

- Alignment of Recycled definitions across multiple applications.
- Tracking and tracing Recycled input materials.
- Providing customers (both brands and consumers) with a tool to make informed decisions.
- Providing assurance that materials in the final product are actually recycled and processed more sustainably.

YOUR PLANET NEEDS YOU





FOREST STEWARDSHIP COUNCIL

The Forest Stewardship Council (FSC) is an international non-profit organization that sets standards and promotes sustainable forest management. FSC was born in 1993 from a conviction that forests have value beyond what can be seen or touched. The goal of FSC is to ensure environmentally responsible and socially beneficial management of the world's forests now and for future generations.

FSC has established global standards for forest management that are verified through independent third-party certification.

Mission

FSC will promote environmentally appropriate, socially beneficial, and economically viable management of the world's forests.

Vision

The true value of forests is recognized and fully incorporated into society worldwide. FSC is the leading catalyst and defining force for improved forest management and market transformation, shifting the global forest trend toward sustainable use, conservation, restoration, and respect for all.





Hello, future note

Hello, future note

Hello, future note

Hello, future note

Hello, future note

Hello, future note

未命名笔记



E30473

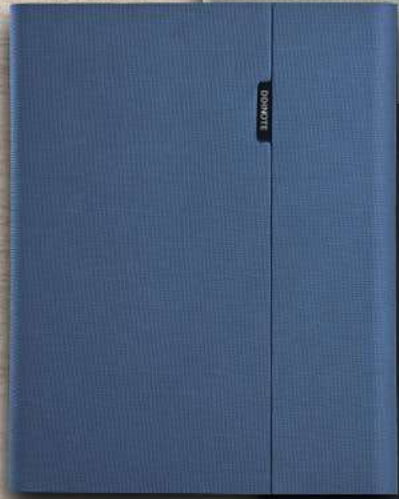

E30472



E30471



Card Holder



Phone Holder



Pen Holder



Notebook

DD NOTE

E3179

DD Note is made from RCS PU Material and with motherboard that allows your handwritten notes and thoughts to travel off the page and be on screen in real time. Simply write on the pages of the Paper Tablet with the Pen for instantly-digitized notes that can be edited, transcribed, organized and shared on your device of choice. Can store up to 50 offline pages. It has extra pen refill. Product Size: 25.3X20X2.6 cm Packaging: FSC Paper Box



HOW IT WORKS



WHAT IS MAGSAFE

The MagSafe is engineered and created for a faster and safer wireless charging that works on Apple iPhone 12 and above models.

It optimizes charging up to 15W peak of its power delivery and intelligently adapts to its condition.

E31801



E31802



E31803



E31804



HOW IT WORKS



A4 MAGLIGHT NOTE E3180

A4 Light up Magsafe 5000mAh Notebook Organizer with 10W wireless charging and 15W cable charging capacity in RSC PU Material. It has Lycra pocket organizer on the inside, foldable phone stand, pen holder and FSC 20 sheets memo pad. With power indicator and TYPE C input and output for fast charging. Product Size: 30.6x24.3x2.5cm Packaging: FSC Paper Box.





E31781



E31782



E31783



E31784



MAGLIGHT NOTE

E3178

Light up Magsafe 5000mAh Notebook Organizer with 10W wireless charging and 15W cable charging capacity in RCS PU Material. It has Lycra pocket organizer on the inside, foldable phone stand, pen holder and FSC 64sheets notebook with elastic closure. With power indicator and TYPE C input and output for fast charging. Product Size: 22.6x 17.5x 2cm. Packaging:FSC Paper Box.





E31393



E31391



E31392



E31394



HOW IT WORKS



MAG NOTE E3139

10W MagSafe A5 Fast Charging 64 sheets notebook organizer with built-in wireless 8000MAH powerbank and 32GB USB. Made from special PU Material with non-stitching welding technology. It has Lycra pocket organizer on the inside, foldable phone stand and pen holder. Its power system on its spine and magnetic flap closure makes it easy to use. With LED power indicator and TYPE C input and output for fast charging. Product Size: 23.2x18x2.5cm. Packaging: Black Drawer Box



Magsafe



Wireless
Charging



Powerbank

MAG DAILY USE E3140

5W MagSafe Daily Use is a classy wallet with built-in wireless 5000MAH powerbank made from a Special PU material. Has Pen holder, card holders, magnetic pocket and lycra pocket with welding non stitching technology. Power system in the spine with LED power indicator. Product Size: 18.2x11x2.5cm. Packaging: Black Drawer Box





HOW IT WORKS



E31841



E31842



E31843



E31844

MAGSAFE PENHOLD

E3184

Foldable Pen Holder Magsafe 15W Wireless Charger Stand with no stitching - welding technology RCS PU Material. Product Size: 16.5x8.2x10.4Hcm. Packaging: FSC Paper Box.



Magsafe



Desktop Organizer



E31852



E31854



E31853



HOW IT WORKS

2 Steps Stand

WIRELESS FOLD

E3185

Foldable 5W Wireless Charger Stand with no stitching - welding technology RCS PU Material. Product Size: 15.5x8x1cm. Packaging: FSC Paper Box.



Wireless Charging



Mobile Stand 1



www.fsc.org



MAG - MOBILE STAND

E3146

10W MagSafe fast wireless charging mobile stand with welding non stitching technology in special PU Material. Product Size: 11x7.8x1.2cm (folded) Packaging: Black Paper Box





E31561

E31562

E31563

TRENDY WIRELESS PLUS2

E3156



Wireless Charging



USB Charging



Powerbank

Improved Trendy Wireless Plus A5 notebook in PU Material with 5000mAh. Has unique and signature design in the middle which can be a business card holder and elastic pen loop above it. Dual Coil for cover and inside cover charging. Magnet closure with elongated metal plate for branding. Inside has mobile stand, elastic pen loop, business card holder, 2 elastics to hold accessories and cables. Has notebook with 56 sheets of cream lined paper and 8 sheets of blank papers, 4 lights battery indicator and hidden USB port. Product Size: 22.5x17x3.5cm Packaging: Paper Box with Cream Sleeve



TRENDY WIRELESS PLUS

E31114

Improved Trendy Wireless Plus A5 notebook in PU Material with 5000mAh. Built-in +NFC Technology. Has unique and signature design in the middle which can be a business card holder and elastic pen loop above it. It also has an icon for the wireless on front side. Magnet closure with elongated metal plate for branding. Inside has mobile stand, elastic pen loop, business card holder, 2 elastics to hold accessories and cables. Has a notebook with 56 sheets of cream lined paper and 8 sheets of blank paper, 4 lights battery indicator and a hidden USB port. Product Size: 22.5x17x3.5cm Packaging: Paper Box with Cream Sleeve



Wireless
Charging



USB
Charging



Powerbank



+ NFC



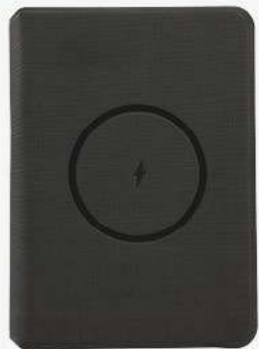

E31411



E31413

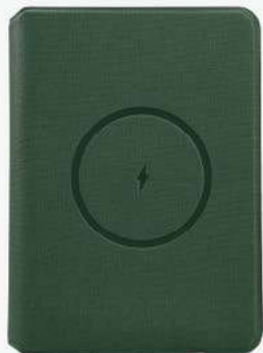

E31414

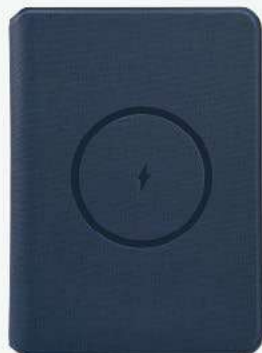

E31412



Wireless Charging



USB Charging



Powerbank

POWER NOTE

E3141

5W Wireless Charger Notebook with 64 sheets paper and 5000MAH Powerbank in special PU material. Has lycra pockets, foldable phone stand, and pen holder. Non-stitching Welding technology. The Power system is in the spine with LED power indicator. Product Size: 23.1x17x2.5cm. Packaging: Black Paper Box



E31132



E31133



Wireless Charging



USB Charging



+ NFC



RPET Material



5000mAh Powerbank



OFFICE MOBILE PRO

E3113

Light Weight RPET Linen Material Computer Bag with 5000mAh wireless charging powerbank. Built-in +NFC Technology. Has 2 metal closure and leather handle. The Inside design has card holder, mobile holder with wireless charging, 2 elongated elastic pen loop, crossed elastics as accessories holder, pocket for documents and laptop sleeve with adjustable stand and an adjustable stand on front part for better hold, 4 lights battery indicator and hidden USB port. Outside has pocket for documents and wide elastic to use for luggage holder. Product Size: 27x34.5x4cm Packaging: Paper Box with Cream Sleeve



E30702

E30703

E30701



TECH WIRELESS E3070

Light Weight RPET Linen Material Computer Bag with 5000mAh wireless charging powerbank. Built-in +NFC Technology. Has 2 metal closure and leather handle. The Inside design has card holder, mobile holder with wireless charging, 2 elongated elastic pen loop, crossed elastics as accessories holder, pocket for documents and laptop sleeve with adjustable stand and an adjustable stand on front part for better hold, 4 lights battery indicator and hidden USB port. Outside has pocket for documents and wide elastic to use for luggage holder. Product Size: 27x34.5x4cm Packaging: Paper Box with Cream Sleeve

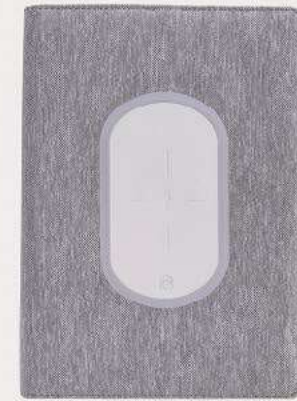

E31120



E31122

CHARGE NOTE

E3112

A5 Linen Wireless Charger Notebook. Built-in +NFC Technology. Has 56 sheets of cream lined paper and 8 sheets of blank paper, with card pockets, transparent plastic pocket, pen loop and magnetic flap closure. Charging port in upper side of notebook. Product Size: 22.8x17x2cm Packaging: non woven sleeve in cream paper box



WIRELESS NOTE

E3116

A5 notebook with 5W Wireless Charger in debossed pattern design. Has 88 sheets of cream lined paper and 8 sheets of blank paper. Charging port in upper side of notebook. Comes with Pen loop and elastic closure. Product Size: 21.5x14x1.7cm Packaging: Non Woven Sleeve in a Cream Paper Box



F31163

F31162

F31161

F31164

F311610



Card Holder Phone Holder Pen Holder Notebook

TRENDY ORGANIZER PLUS E3136

Improved Trendy Organizer with A5 notebook in PU Material. Has unique and signature design in the middle which can be a business card holder and elastic pen loop above it. Got a magnet closure with elongated metal plate for branding. Inside has mobile stand, elastic pen loop, business card holder, 2 elastics to hold accessories and cables. Has a notebook with 56 sheets of cream lined paper and 8 sheets of blank paper. Product Size: 22.5x17x3.5cm Packaging: Paper Box





E31422



E31424

E31423

E31421



BIND ORGANIZER

E3142

A5 80 sheets Binder Organizer in special PU material. Has 2 year Calendar on the first sheet with Pen holder and magnetic flap closure. Product Size: 22.6x18x2.2cm Packaging: Black Paper Box



Pen Holder



Notebook



Card Holder



Phone Holder



E31981



E31982



E31983



E31984



POCKET NOTEBOOK E3198

Soft A5 Multi-Pocket FSC 80 sheets notebook with a combination of stitching and welding technology RCS Lycra Material. Product Size: 21.3x14.4x1.5cm. Packaging: FSC Paper Box



E31181

E31185

E311827

E31182



SOPHI USB NOTE **E3118**

A5 Notebook with USB in wavy design, compressed foam technique. Has 88 sheets of cream lined paper and 8 sheets of blank paper. Has metal plate for branding and elastic closure. Product Size: 21x14x1.5cm
Packaging: Non Woven Sleeve in a Cream Paper Box.



E31172



E31175



E31171



E31177

SOPHI NOTE E3117

A5 Notebook with wavy design, compressed foam technique. Has 88 sheets of cream lined paper and 8 sheets of blank paper. Has Built-in NFC Technology, metal plate for branding and elastic closure. Product Size: 21x14x1.5cm Packaging: Non Woven Sleeve in a Cream Paper Box.

E31481



E31482



E31484



E31483



Card Holder



Phone Holder



Pen Holder



Notebook

SIMPLE NOTE

E3148

A5 linen 80 sheets notebook with lycra front pockets and pen holder in special PU material. Product size: 21.5x14.2x1.5cm. Packaging: Polybag



A6 SOFTY NOTEBOOK

E3150

A6 Soft PU notebook in thermal PU cover and elastic band for closure. Comes with yellow sticky note 7.6 x 7.6cm, 25sheets; 5 colors PET flag 1.2 x 4.5cm, 25sheets each color. Inner pages; 80sheets of 80g beige lined paper. Product size 10.1 x 14.5 x 1.3cm Packaging: Polybag



A5 SOFTY NOTEBOOK

E3151

A5 Soft PU notebook in thermal PU cover and elastic band for closure. Inner pages; 100sheets of 80g beige lined paper. Product Size: 14.5 x 21 x 1.1cm Packaging: Polybag



E30801



E30802



E30807



E308021

CHIC NOTE

E3080

A5 PU Notebook with 96 sheets of cream paper; paper size: 14.2x20.8cm and 80 GSM. It has ribbon bookmark, elastic pen holder at the backside of flap and metallic button for closure while the spine has silver part - metal strip. Product Size: 21.2x14.1x1.4cm Packaging: White Paper Box



Pen Holder



Notebook



STATIONOTEPAD E3122

Stationery Notepad in Thermal PU Cardboard Cover. Has 70sheets of Yellow Sticky Notes 10x7.7cm, ; Neon Color Sticky Pad 7.7x2.5cm X 4 colors, 70sheets each color; Memo 20.3x15cm, 60 sheets of 70g beige paper with 1c printing, 10 sheets of blank paper; 12sheets calendar, 20.2x8.3cm, 157g art paper with 4c printing on one side; and a ball pen with blue color refill. Product Size: 24x20.7cm Packaging: Paper Box

STICKY NOTE E3123

Sticky Note with Thermal PU Cover and White Card. Inner left side big sticky note 15x9.6cm, 10 sheets each color with lined printing, 6colors. PET flag: 1.2x4.5cm, 25sheets each color, 6colors; Right side with sticky note 9.6x7.7cm, 15sheets each color with 1c printing, 4colors. Sticky note 9.6x6.6cm, 15sheets each color, 4colors, small sticky pad 4.5x4.4cmX2pads, 45sheets each pad. Product Size:20.6x10.2x1.3cm Packaging: White Paper Box



E31381



E31382



E31384



E31383



MODULAR PORTFOLIO

E3138

Sticky Note with Thermal PU Cover and White Card. Inner left side big sticky note 15x9.6cm, 10 sheets each color with lined printing, 6colors. PET flag: 1.2x4.5cm, 25sheets each color, 6colors; Right side with sticky note 9.6x7.7cm, 15sheets each color with 1c printing, 4colors. Sticky note 9.6x6.6cm, 15sheets each color, 4colors, small sticky pad 4.5x4.4cmX-2pads, 45sheets each pad. Product Size:20.6x10.2x1.3cm Packaging: White Paper Box





E30682

E30683

E30681



Mobile Stand 2



A4 Notepad



Phone Holder



Pen Holder



Card Holder

TRENDY PORTFOLIO

E3068

A4 PU Portfolio with unique design of flap which can be a business card holder with elastic pen loop above it and elongated metal part for branding. Inside has mobile stand/holder, elastic pen loop, business card holder, 2 elastics to hold accessories and cables, pockets for documents and 25 sheets memo notepad. Product Size:31x23x1.3cm
Packaging: White Paper Box

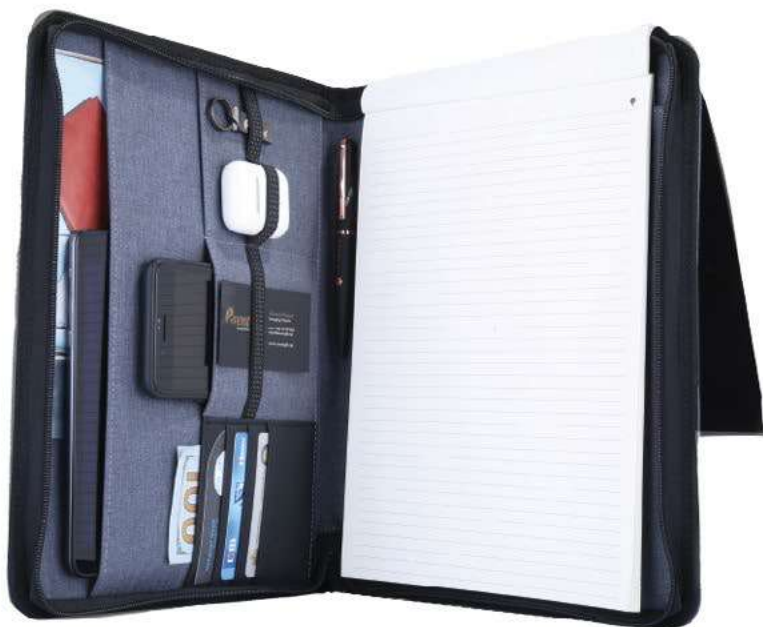

BUSINESS FOLDER E3074

A4 Linen Folder designed with a flap as a pen loop and business card holder. Has pockets inside for mobile, documents and cards. An elastic to hold accessories and cables and a pen loop as well. Comes with 25 sheets memo notepad. Product Size:32.5x24.8x2.5cm Packaging: White Paper Box



Phone Holder



A4 Notepad



Card Holder



USB Charging



4000mAh Powerbank



Card Holder



Phone Holder



Pen Holder



LINEN TRAVEL CASE E3037

4000mAH Powerbank Travel wallet in linen material, with mobile pocket on the cover. Has business card, passport & money holders with a mesh pocket. Includes 30 sheets small notepad & pen loop and comes with brown rubberized metal plate with chrome plating and screen battery indicator on the back side. Grey with Brown color. Product Size:10.5x19.5x2.2cm Packaging: White Paper Box



RFID BLOCKING WALLETS ARE ESSENTIAL IN THIS ERA!

In this world where in people no longer carry cash but just use cards in every transactions, RFID Blocking wallets are important. It prevents RFID readers to get vital information from RFID-based credit/debit cards, passports, and ID cards that are in the wallet.

ANTI-IDENTITY THEFT

our belongings that contains personal identification and bank cards need to be shielded with RFID blocking wallet to ensure that our information is safe.

RELIABLE

the assurance of having our belongings safe from unwanted theft frequencies.

TRAVEL SECURITY

to make travelling safer and assured, these RFID bags and wallets are needed for security purposes.

DESIGN CONFIDENCE

make RFID wallets unique and fashionable with designs that matches your style, outfit or activities.





Powerbank



RFID SAFE



Wireless Charging

WIRELESS P-TRAVEL

E3072

Wireless Travel Wallet with RFID Protection and 4000mAh powerbank in linen and PU material. Has Lycra mobile pocket, business card holder, PU pen loop and pockets for document and passport, a sim card holder and iPhone pin inside. Battery screen indicator on backside. Product Size:21x12x2.5cm Packaging: Black Elegant Box



E30731



E30733



E30732



RFID SAFE



P-TRAVEL

E3073

Travel Wallet with RFID Protection in linen and PU material. Has Lycra mobile pocket, business card holder, PU pen loop and pockets for documents and passport, with a sim card holder and iPhone pin inside. Product Size:21x12x2.5cm Packaging: White Paper Box



E3132

E3131

RFID ALU WALLET

E3135

A new sleek design of wallet in special PU material. RFID safe wallet with Aluminum strip design for a more elegant look. Product Size:11.5x8cmx0.6cm (folded size) Packaging: Brown Paper Box



RFID SAFE



E3201



E3202



E3203



E3204

RFID CARDHOLDER

E3201

Multi-pockets RFID safe card holder in RCS PU Material. Product Size: 14.5x10.3x0.7cm. Packaging: FSC Paper Box.



Introduce yourself using NFC CARDS



In this fast paced mobile-enabled world, efficiency and effectiveness are the passport to building and growing the professional network and staying competitive. Digital business cards is one such invention to make your professional or entrepreneurial journey smooth and efficient.



NFC CARD E1332

A blank 13.56MHz NFC card – often used for train/bus passes but also found in other systems where a proximity card is desired.

The card tag contains a small NFC chip and an antenna, and is passively powered by the reader/writer when placed a couple inches away.



RFID FOLDY E3092

Tri-Fold RFID safe card holder in a special material with no-stitch welding finish technique. Has built-in NFC Technology, Can hold up to 8 cards, black plastic folded money pocket and flap with button closure. Product Size:10x7.5x2cm Packaging: Cream Paper Box





RFID CARDHOLD E3093

RFID safe card in PU material. Can hold up to 8cards with pocket outside to hold money and others. Product Size:11x6.8x1.2cm
Packaging:Paper Box



RFID M-CARDHOLD E3149

RFID safe card in PU material. Can hold up to 8cards with pocket outside to hold money and others. Product Size:11x6.8x1.2cm
Packaging:Paper Box



E31451



E31457

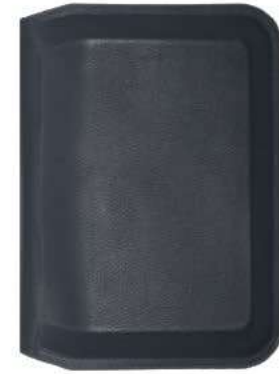

E31452



MAGNETIGHT WALLET

E3145

RFID magnetic PU Leather wallet that can hold up to 7 cards with 3D card shaped design and no-stitching heat welding finish technology. Product Size: 10.6x7.5x 0.8cm Packaging: Black Drawer Box



E31691

E31697

E31692

SMART MOBCASE

E3169

All in one PU material Mobile Case and stand. Has Magnetic Flap for closure. Product Size: 18.5x11x 0.3 cm. Packaging: Black Paper Envelope



SMART LAPCASE E3147

Clean look and functional 14" laptop sleeve organizer with smart stand. The magnetic flap can be folded as laptop stand with 2 different angles. Has flexible pockets to fit all kinds of accessories with non-stitching heat welding finish technology. Product Size: 36x25.2x1cm. Packaging:Black Paper Envelope



HOW IT WORKS





E31811



E31812



E31813



E31814



OFFICE LAPFOLD

E3181

PU Laptop sleeve turned to Workstation when opened - can be used as laptop stand with mousepad and other accessory made from RCS PU Material. Product Size: 36.8x26.5x2cm. Packaging: FSC Paper Box.





F31821



F31822



E31823



E31824



DESKMATE E3182

Foldable Desk Pad Organizer with laptop stand and two magnet bamboo organizers. One is pen & business card holder and the other one Has 15W wireless charger and light up piece. Material has no stitching - welding technology RCS PU Material. Has a part that can be used as mousepad with armrest which is very perfect for daily desktop activity. Product Size: 80x29.8x1.8cm (open) and 40x29.8x1.8cm (folded) Packaging: FSC Paper Box.



HOW IT WORKS



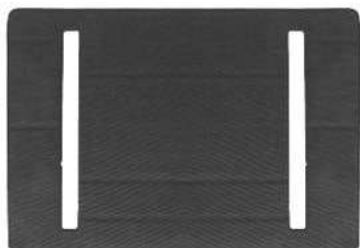

E31201



E31202

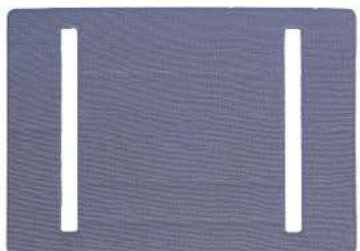

E312026

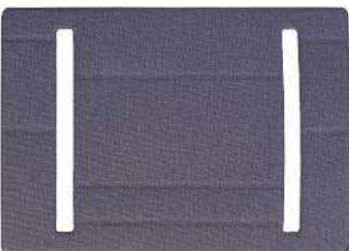

E31203

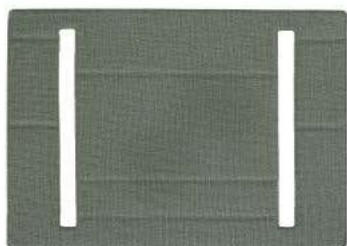

E31206

LAPPY STAND E3120

Laptop Stand in a Special Material with no-stitching Welding finish Technique. Adjustable for better angle and position, with high quality sticking pad for safe hold of the laptop. Product Size:22x16x0.2cm
Packaging: Polybag



Laptop / Tablet Stand



Laptop / Tablet
Stand



ALU LAPPY HOLDER E1355

Durable, Lightweight and stylish foldable laptop holder in ergonomic comfortable design made of Aluminum, has rubber pads to protect your laptop and desk from scratching. Product Size: 22.8x22.5x15cm. Packaging: Paper box





HOW IT WORKS



E31831



E31832



E31833



E31834

MOUSEPAD ORGANIZER

E3183

Unique foldable welded RCS PU Material mousepad with a magnet bamboo organizer having 15W light up wireless charger. Material has no stitching - welding technology. Product Size: 20.5x20x2.7cm (open) 20.5x8.8x2.7cm (folded); Packaging: FSC Paper Box



Wireless Charging



HOW IT WORKS



Wireless Charging



E31431



E31432



E31433



E31434

W-PAD ORGANIZER

E3143

10W Fast charging wireless mouse pad with Type C input made from a Special PU material. Comes with desktop organizer that can hold 4 pens, a space for business cards which can be used as phone stand. Product Size: 23.5x 22x 0.7cm (folded) Packaging: Black Paper Envelope



PAD ORGANIZER

E3144

Mouse pad made from a Special PU material. Comes with desktop organizer that can hold 4 pens, a space for business cards which can be used as phone stand. Product Size: 23.5x 22cx 0.3cm (folded) Packaging: Black Paper Envelope



FOLDY CORK MOUSEPAD

E3172

Foldable Mouse pad in cork material with 5W Wireless charger. Can be folded as mobile stand. Product Size: 20.2 x 8.5x 0.9cm (Folded); 26.4 cm (L when opened). Packaging: Black Paper Box



Wireless
Charging



Sustainable
Material



USB
Charging



Universal
Standby



Desktop
Organizer

WRITE PAD

E3079

Writing Mousepad with designated mobile/tablet stand, pen holder and with E-Note pen. Product Size:24.5x26.5x2.5cm, Packaging: White Paper Box.



ALU COASTER

E3060

6pcs Aluminum cup matt with Eva fabrics on backside and has round shaped holder. Product Size:9.5x3cm Packaging: White Paper Box



HAPPY COASTER

E3055

6pcs Coasters set with mixed PU and felt material designed with smiley face. Has 3 buttons to hold the coasters. Product Size:9.5x4cm Packaging: Polybag.



BAMBOO COASTER

E6026

Bamboo coasters set consist of 5 round coasters with a holder. Product Size:15x9x5cm Packaging: Recycled paper box





KEYHOLD E1352

Keyholder with PU combination and gunblack metal finishing.
Product Size: 9.7x3.4cm Packaging: BlackPaper Box



E31991



E31991



E31992



E31993

LUGGAGE TAG E3199

Luggage Tag in RCS PU Material with 2mm thick wire cable loop. Product Size: 21.3x14.4x1.5cm. Packaging: 6x11cm. Packaging: FSC Paper Box.



E32001



E32002



E32003



E32004

RFID PASSPORT HOLDER E3200

RFID Safe Passport Holder in RCS PU Material. Product Size: 10.3x14.4x0.4cm. Packaging: FSC Paper Box.





E31752



E31753



E31754

ID HOLDER BLACK E3175

2n1 ID Holder and Card Holder with no stitching - welding technology
RS PU Material. Product Size: 10.3x14.4x0.4cm. Packaging: FSC Paper Box.





03

SUSTANABLE

104	107	ECO CUP
108	109	WHEAT
110	111	CORK
112	113	RPET
114	117	GENUINE RECYCLED LEATHER
118	123	BAMBOO
126	128	RECYCLED PAPER



Bamboo is one of the widely-used materials to make eco and sustainable by-products. Its wood can be made into household products, kitchen utensils, decorations and even technology items.

The trimmings and cuttings of the bamboo will not go to waste because it can be made into something else. Starchy pulp is produced from bamboo trimmings, stems and leaves, through a process of alkaline hydrolysis and multi-phase bleaching. Further chemical processes produce bamboo fibre which creates garments, textiles, medical products, kitchen wares and others.



MANUFACTURING PROCESS:





E70440



E70441



BAMCUP E7044

350ml Drinking Cup made from Bamboo fiber and silicon cover. Product Size: 10x9cm diameter. Packaging: Paper Box.

Coffee Grounds

About 40-30% of the world's population consume coffee every day. Approximately, around 15 million coffee shops and cafes are operating around the world. Ever wonder what they do in their coffee waste? Coffee grounds and byproducts are the waste from brewing coffee, which are mostly seen in coffee shops. These small grains or beans are the leftovers from producing a very good cup of coffee. A lot of people throws it away, while in fact, it can be used in many useful and creative ways.



Coffee Grounds



Coffee Pellets



Mug (Product)

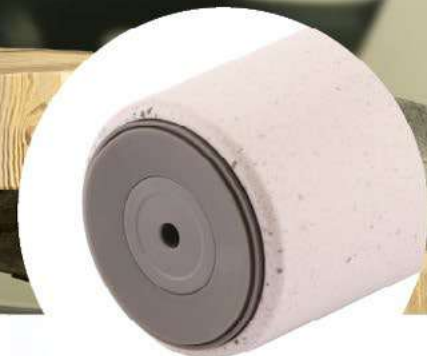

COFI MUG E7037

350ml Double wall Suction cup made from recycled coffee grounds outer cover and 304 stainless steel inside. This BPA free Never fall mug is great for hot and cold drinks and leak proof. Product Size: 15cm x 8.3cm Diameter. Packaging: Paper box.





Earth Friendly Wheat Straw Material is Fully Biodegradable

What is Wheat Straw Material?

Wheat Straw is the stalk left over after wheat grains are harvested. Traditionally, it has been treated as a waste. In some countries, farmers burn it, contributing to air pollution and creating a public health hazard. However, these stalks still have value. We reclaim this material and use it to make our wheat straw products.



WHEAT LUNCH KIT

E6050

A Sustainable single layer lunch box made in recycled wheat straw material with PP and bamboo cover. Has Spoon, Fork and Knife in a brown elastic band for better closure.
Product Size:16.6x11.5x 5.4cm. Packaging: Polybag.



**BIO FAMILY
WIRELESS
CHARGING PAD**
E5057 - REFER TO PAGE



**YOYO SPEAKER
WHEAT**
E6035- REFER TO PAGE



**POKKAT 2
WHEAT**
E5056 - REFER TO PAGE



**WHEAT
SPEAKER**
E5080 - REFER TO PAGE

WHY CORK MATERIAL IS SUSTAINABLE AND GOOD MATERIAL?

- The bark is carefully stripped, no need to cut down the trees itself. After sometime, the bark grows back to be harvested again



- The stripped bark can get as much as 5x carbon from atmosphere. For Every kilo produced cork, 55kgs of CO₂ is absorbed by the tree



- Cork is Hydrophobic, means it is has dirt retention, anti-microbial, and is odour repellent.



- Cork raw material is naturally moisture-wicking, cushioning, insulating, fire-resistant, biodegradable, buoyant and beautiful.



Eco Friendly



CORKNOTE SET

E6051

Nice and sleek design for a sustainable set that consist of A5 notebook in cork & linen cover with 96 sheets 70g ruled ivory paper & pen loop and cork ballpen packed in kraft paper box. Product Size: 23.5x19.5x2cm (box).



CORKLEY SPEAKER E5067

Please refer to page



CORK MOUSEPAD E3172

Please refer to page

"FEEL GOOD WHEN USING SOMETHING THAT HELPS A CAUSE"

Wanted to promote their standpoint on environmental awareness, while showing something relevant to their industry?
i.e. what happened to all those blue water bottles people put in their blue bins each day.

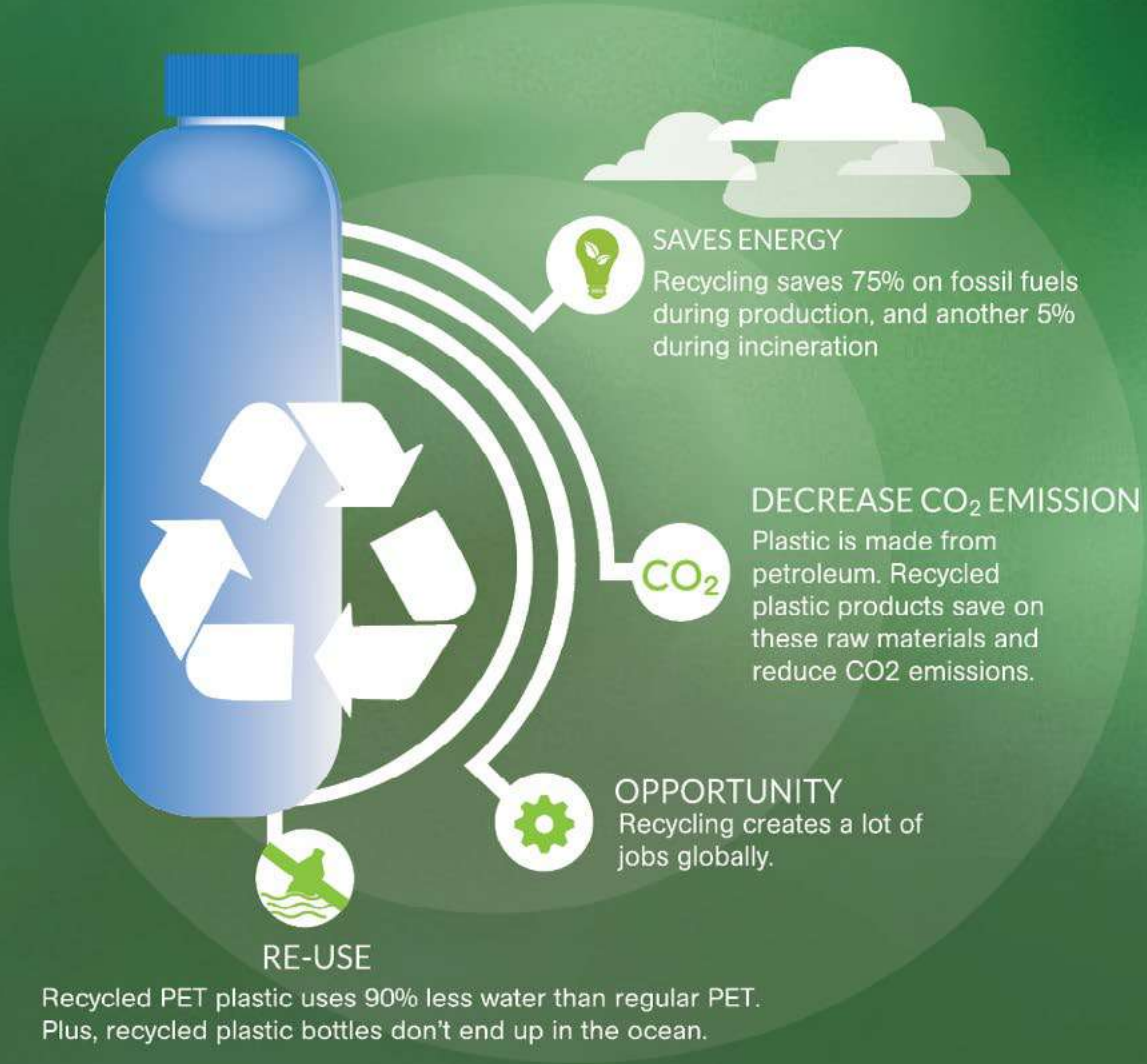

How we produce our RPET Items?

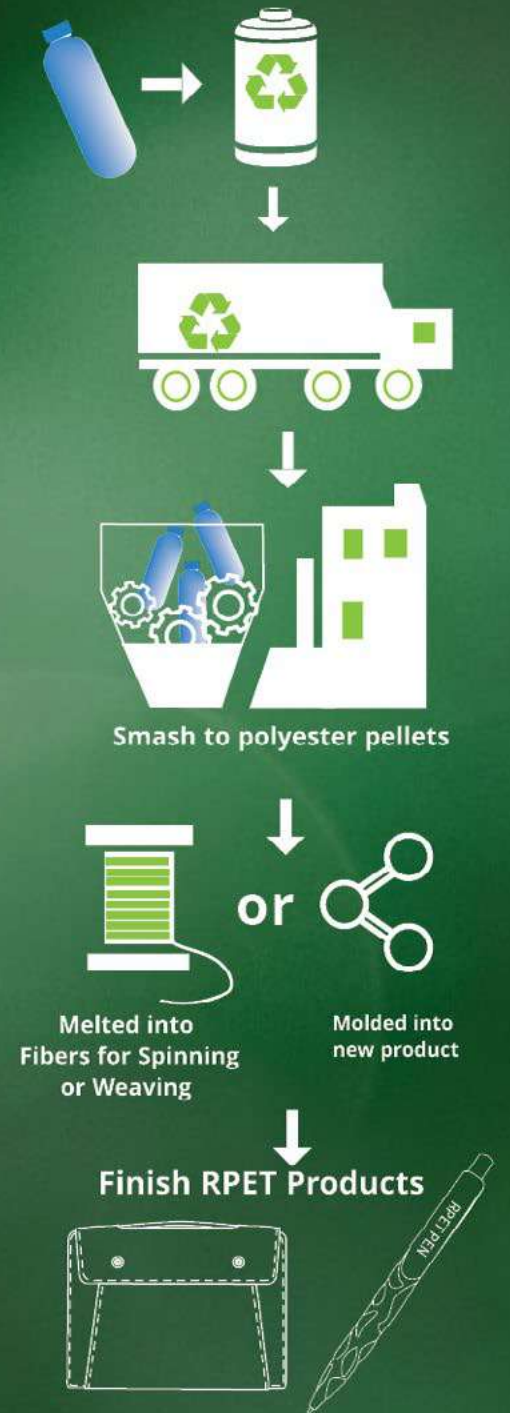



**OFFICE MOBILE PRO
E3113**

Please refer to page



**BOTTLE PEN
E1225**

Please refer to page



**RPET PEN
E1216**

Please refer to page

WHAT IS RECYCLED LEATHER?



Genuine Leather scraps are collected from furniture, shoes, and other products and factories.



This leather used to go to waste and adds up to the landfills.



But now its ground into shreds, combined with water and then mixed with binding products such as natural rubber and acacia wood bark to make a goof use of it.



Most recycled leather is a composite of shredded leather scraps and residues collected from tanneries and other leather product manufacturers.



Is recycled leather sustainable?

Recycling of materials creates a circular economy and therefore increases sustainability.

Also it take less resources to recycle geniune leather than synthetic materials.



Wireless
Charging



Notebook



Card Holder

LEATHEREC NOTEBOOK

E6042

A distinctive A5 notebook in a recycled genuine leather material neatly bound with lined paper. Has inside pockets for business cards, documents and a pen holder. Product Size:17x22.2X2.4cm. Packaging: Kraft Paper Box.





LEATHEREC WIRELESSBAMBOO PAD E6041

A 10W Wireless charger mousepad desktop organizer best in office use for your daily activities. The organizer is made from bamboo, designed to fit all your daily office needs. The mousepad is made from recycled genuine leather making the whole item sustainable and eco-friendly. Product Size:25x25x3.2cm. Packaging: Kraft Paper Box.



LEATHEREC CARD HOLDER

E6043

A unique classic folded card holder wallet with pockets and card inserts. Has a ribbon underneath the pocket for easier pulling of cards.
 Product Size: 7.5x10.2x0.7cm. Packaging: Kraft Paper Box



LEATHEREC PASSPORT HOLDER

E6044

A nice passport holder made from recycled genuine leather material giving a classy look to your passport. Has card holders inside. Product Size: 9.5x13.7x0.9cm (folded size). Packaging: Kraft Paper Box



A detailed line drawing of bamboo stalks and leaves in the top left corner, rendered in a light brown color.

Bamboo

A Sustainable Material

THINK GREEN? .. GO WITH BAMBOO

A highly sustainable material called Bamboo is the fastest growing plant. A member of the grass family, bamboo is known for tall hollow stems that reach their full height in just one growing season.



Durability



Water Resistant



Cost Effective

Natural Anti-Bacterial

Bamboo naturally contains an anti bacterial agent, bamboo kun, that prevents, kills or reduces the growth of bacteria.





BAM ORGANIZER E6039

A Bamboo desktop organizer with 350GSM art paper printed calendar and bamboo mouse pad. Has 100 sheets sticky note, 5 colors 150 sheets arrow shape sticky note, 40pcs clips and ballpen. Packed in a black special paper cardboard with PVD lid.

Desktop Size: 2.9*12.9*21cm ; Calendar Size: 20.8x16.6cm Mousepad Size: 20.8x16.6cm. Packaging Size: 19.9x24.1x4.4cm Packaging: Black Sleeved Box



Pen Stand and Decoration stand to make your desk lively!

Keep your mobile phones here! 99% Phone sizes can be fit inside.

Miscellaneous stuff in your office that needed to reach your hand easily



Small items pins, USB's that can be keep here, so no need to find it anywhere inside your cabinet



CREATIVELY DESIGN FROM DIFFERENT SHAPES THAT CAN BE USEFULL TO KEEP TRACK ALL YOUR NECESSARY ITEMS THAT YOU DON'T WANT TO LOSE IN YOUR CABINET!

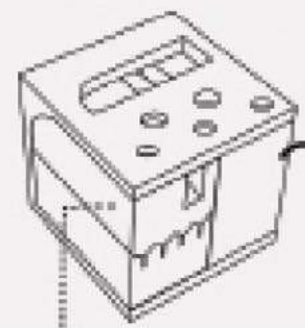

We are studying the design layout using our own experiences in using office organizers



Desktop Organizer

Business Card insert or Pens can be keep here



The concept came from scratch idea to drawing until we get through the final product.

We look out what is best for the users to have real professional look in their desk without taking up too much space in your table as well as utilizing the design to its best USE.

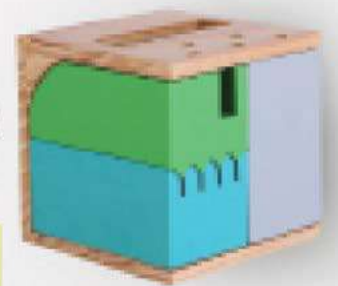

ORIGINAL DESIGN

Made from bamboo material, E-Cube is one of the item that proudly stand for sustainable goal instead of using plastic material or unhealthy metallic desktop organizers.



Bamboo Product



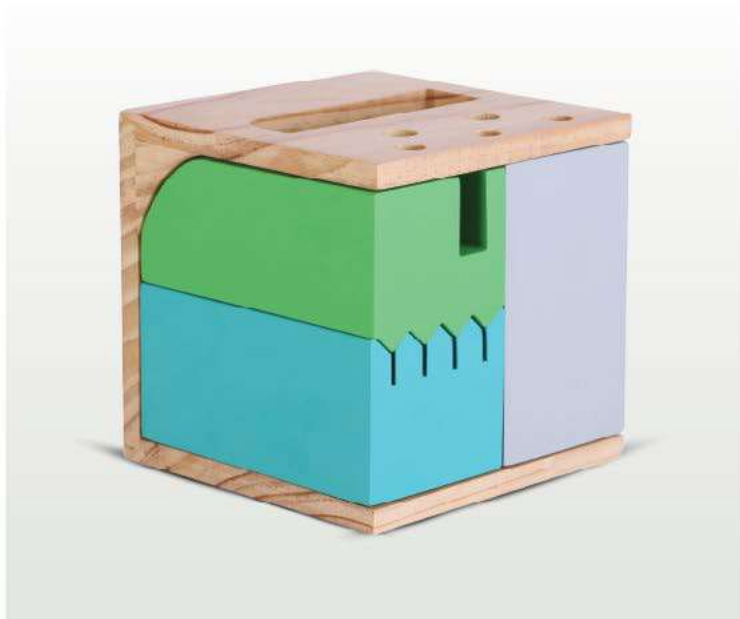

E-CUBE

E6032

An original design of an Eco Desktop item made from 100% Bamboo Material. An organizer with 3 mini drawers that can be arranged according to your space and mood which serves as phone holder, business card holder, pen stand, accessories holder and others. Product Size:12x12x12cm Packaging: Kraft Box.



HOW IT WORKS



Desktop Organizer



Bamboo Material

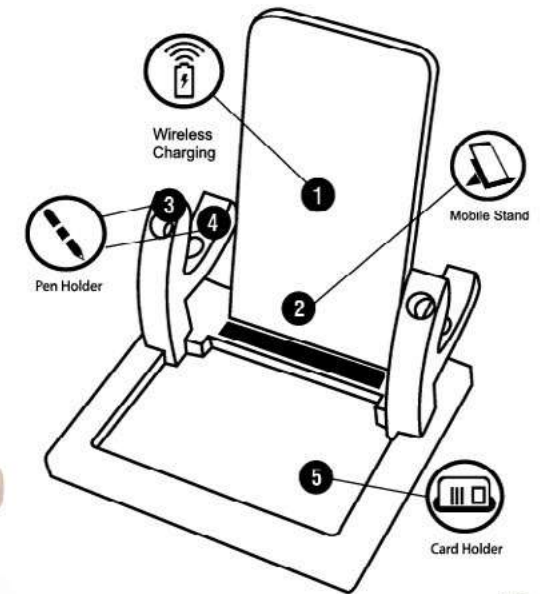

WIRELESS LOUNGE E6033

New Desktop Organizer-Phone Holder with Wireless Charger made from 100% Bamboo Material. Has a unique pen holder, business cards and accessories slot with a wider branding space.

Wireless Input: Wireless Output: Base

Product Size: 14.4x12x1.2cm Packaging: Kraft Box



● UV light

● Main compartment with removable divider

UVC STERILIZER ORGANIZER

E6037

A UVC Box made with a special two tone Fabric and PU with bamboo cover. Has 3 original Ultra violet C light inside it assuring to kill all harmful virus and bacteria. Dividers are removable and detachable for easy item placement. Has zipper to ensure proper closure making UVC light to work perfectly inside the box. Sanitizing time is at 1min and 3mins option. Product Size:19x7x12.5cm Packaging: Paper Box.



CURVEY

E6025

Curvey Unique-shaped made in bamboo material including small notepad and 3 colorful memo stickers. It has mobile holder, pen holder, business card holder, and an open space for the accessories as well.

Product Size: 25.5x9x9cm

Packaging: Kraft Box



SMART DESK ORGANIZER

E6022

2pcs Square shaped bamboo with diecuts to fix together including 3 colorful memo stickers and calendar. This item can be used as mobile holder, stylus and normal pen holder and business card holder. On the side there are 3 curves where you can hang usb, watch or any small accessories. It has good branding space as well. Product Size: 18x17x1.5cm
Packaging: Kraft Box





BAMBOO COASTER E6026

Bamboo coaster consist of 5 round coasters with a holder. Product Size:15x9x5cm Packaging: Recycled paper box.





TRI-FOLD STATIONERY

E6018

Stationery set with cover craft paper with cardboard; left side: 1pc ruler, 1pc ball pen, 1pc eraser, 1pc sharpener, 2pcs pencils; middle side: 40 lined sheets memo, 80g beige paper, 20.7*13.7cm; right side: name card holder, yellow sticky note 7.5*7.5cm, 25 sheets, PET 4.5*1.2cm, 25 sheets/color, 5 colors.



E60182



E601810



NOTEBOOK KRAFT A5 E60111

Recycled paper notebook A6 size, with elastic closure includes 70 Kraft paper sheets with lines, sticky notes & colored stickers.
 Product Size:14.2x10cm Packaging: Polybag



E60201

E602010

RECTA DESKTOP E6020

Natural Paper with 2mm thickness cardboard holder. Inner paper notepad, 8*8.6cm, 300sheets total with paper sleeve . PET flags 1.2x4.5cm,20sheets each color. Yellow sticky pad 5x7.5cm, 25sheets. With two pieces of magnet inside the box.

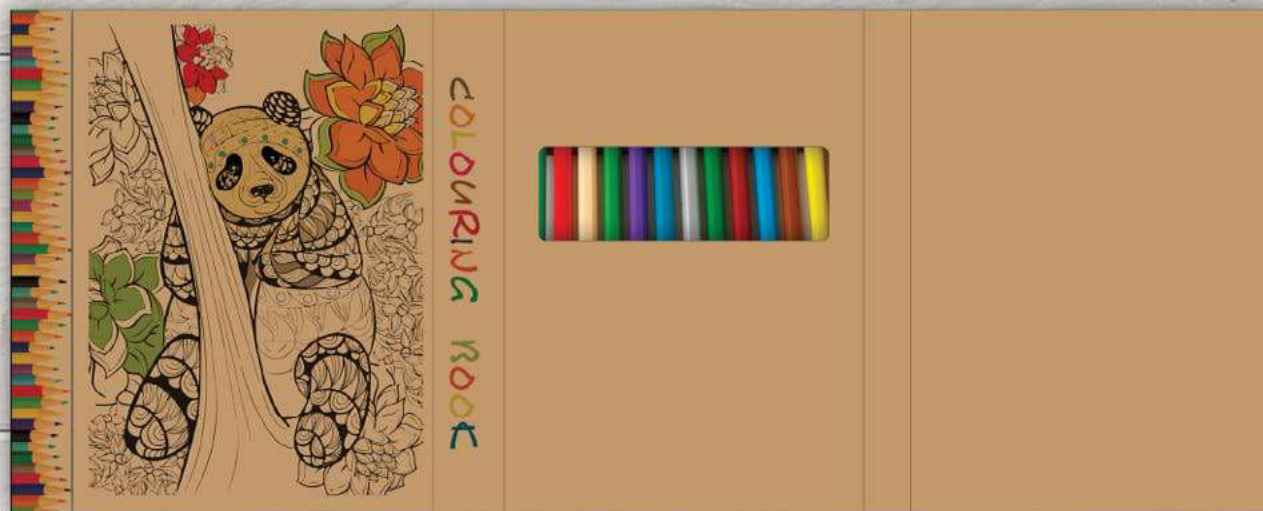

COLOURING BOOK

E6034

Tri Fold Kraft Coloring Book with 24 pcs Coloring Pencils and 50 sheets 100GSM coloring pad which can be enjoyed by kids and adults.
Product Size: 15.5x21x2.7cm Packaging: Polybag



Modernization is essential in this fast paced world.
Innovations can still be done without harming our nature.

**Let us save Mother Earth and be responsible
for our future generations.**



DRINKWARE



04

DRINKWARE

132	143	FLASK
144	151	SUCTION MUG
151	155	CERAMIC MUG
156	157	WATER BOTTLE







Excellent
Corrosion
Resistance

Highly
Heat-Resistant
Grade



CALYPSO FLASK

E7042

500ml double wall vacuum flask with unique geometric shape made from 304 stainless steel. Hot and cold up to 12 hours. Product Size: 22.4x6.7cm diameter. Packaging: Paper Box



CALYPSO TUMBLER

E7043

330ml double wall vacuum tumbler with unique geometric shape made from 304 stainless steel. Product Size: Packaging: Paper Box



E70330

E70332

E70339

E70331

E70338

E70334



- ✓ BPA free
- ✓ Double wall
- ✓ Leak-resistant



MACERATA THERMO MUG E7033

A 340ml Thermo Mug with matt finishing, can hold your favorite hot and cold drinks for 2-3 hours. Comes with a leak proof cover. Perfect design for daily use at home, office or travel. Material: Inner PP, Outer SS201, Tritan Lid Product Size: 87x93x120mm Packaging: Paper Box

1

Choose Your Mug



2

Choose Your Ring Color



3

Choose Your Sleeve Color



4

Choose Your Branding



Bayamo



BAYAMO THERMO MUG

E7031

A 230ml capacity premium quality matt stainless steel thermal mug with anti-fingerprint paint. Double wall mug that can hold and cold drinks for 4-6 hours. Leak proof with trendy design. Silicone Grip and Ring can be customized with your desired colors. Perfect for office, home or travel. Material: Body – Inner SS304, Outer SS201, Lid – PP, Silicone with Power Coating finishing Product Size: 92(Dia.) x 143(H)mm Packaging: White Paper Box

Family

E70320

E70311



Hot, warm or cold it is all a question of perfect insulation



BAYAMO MEZZO

E7032

A 320ml capacity premium quality matt stainless steel thermal mug with anti-fingerprint paint. Double wall mug that can hold and cold drinks for 4-6 hours. Leak proof with trendy design. Silicon Grip and Ring can be customized with your desired colors. Perfect for office, home or travel. Product Size: 92(Dia.) x 164(H)mm Packaging: White Paper Box





- ✓ Double wall with copper-vacuum insulation
- ✓ Leak-proof
- ✓ Dishwasher safe
- ✓ Micro powder coating
- ✓ BPA free



THIONVILLE THERMO MUG

E7034

Premium quality 380ml capacity, can hold hot and cold drinks up to 4-6 hours. Double wall thermo mug with matt powder coating finishing. Has a push button on the cover to open for easy drinking. Material: Inner & outer SS304, PP with Black lid. Product Size: 84(Dia.)x162(H)mm, Packaging: Paper Box.



E701521

E70150

E70151



TRAVEL FLASK PLUS E7015

350ML Travel Mug with normal matt color coating on body part and PP on cover. Can hold coldness and hotness in 6-4 hours. Normal paper box for packaging. Packaging: White Paper Box
Dimension: 17cmx25cm diameter



E70452



E70453



E70451



E70450

SUPREME MUG E7046

300ml slim mug with inside and outside 304 Stainless steel body material. This double wall mug has cover plastic lid with silicon O-ring. Product Size: 9.8x8.5 Diameter. Packaging: Paper Box



SUPREME FLASK E7045

750ml ergonomic shape double wall flask is made from 304 Stainless Steel material - inside and outside. Can reach up to 24-12hours hot and cold preservation. Product Size: 24.2x6.6 Diameter. Packaging: Paper Box.

UPTO
24 HOURS
HOT & COLD
PRESERVATION



E70450



E70451



E70452



E70453



**OUR ENVIRONMENT
FRIENDLY
WATER BOTTLES**

OTG FLASK

E7041

600ml Double wall flask bottle made from spray paint coated 201 stainless steel and 304 stainless steel inside. Can reach up to 12hours hot and cold preservation. Product Size: 26cm x 6.6cm Diameter. Packaging: Paper box

UPTO
12 HOURS
HOT & COLD
PRESERVATION



E70412



E70411



E70410



E70413



E70393



E70390



E70391



E70392

SUCTION MUG E7039

350ml double wall mug made from ABS outside and 304 stainless steel inside. This BPA free Never fall mug is great for hot & cold drinks and leak proof. Product Size: 15cm x 8.3cm Diameter. Packaging: Paper box





E70381

E70380

E70382

E703818

E70383



TALL SUCTION MUG

E7038

500ml double wall mug made from ABS outside and 304 stainless steel inside. This BPA free Never fall mug is great for hot & cold drinks and leak proof. Product Size: 18.5cm x 8.3cm Diameter. Packaging: Paper box





COFI MUG E7037

350ml Double wall Suction cup made from recycled coffee grounds outer cover and 304 stainless steel inside. This BPA free Never fall mug is great for hot and cold drinks and leak proof. Product Size: 15cm x 8.3cm Diameter. Packaging: Paper box.





E70440



E70441



BAMCUP E7044

350ml Drinking Cup made from Bamboo fiber and silicon cover. Product Size: 10x9cm diameter. Packaging: Paper Box.

PRINT ME MUG

E7040

Easy to assemble and great for advertisement. 500ml double wall mug made from PS outside and 304 stainless steel inside. This BPA free Never fall mug is great for hot & cold drinks and leak proof. Product Size: 20cm x 8.5cm Diameter. Packaging: Paper box



CAR CUP



TWIN WALL



STRONG GRIP PAD



BPA FREE



PLAIN PAPER INSERT

Print Your Brand



PRINT A DESIGN OR PHOTO

YOUR PERSONALIZED MUG





SMART MUG

E7012

350ml / 12oz Stainless steel vacuum insulated suction mug with push button to open the cover and holder for easy carry. Inside has silicon cover to maintain the temperature. Product Size: 7.8x7.8x2.20cm
Packaging: White Paper Box



SUITABLE FOR DAILY USE

- suction cup to prevent an unintentional fall.
- The finest craftsmanship on the top rim, offers the best drinking experience.
- The best comfort comes from a one-of-a-kind pattern and texture.
- Food safe material.
- Food grade material is used.
- If hit accidentally, it will not fall.
- 290 ml capacity.
- 6 vibrantly coloured glasses.

PARTY SET SUCTION CUP

E7025

290ml Party Suction Cups, has 6pcs in a set with vibrant color glasses and high-quality suction bottom. The set is made of Certified High Food Grade Material. Packaging: Printed Paper Box



Features:

- Leak Proof
- 410ml
- BPA Free
- Suction Feature
- 24cm x 7.6cm
- Single 304 Stainless Steel Interior (Boiling Liquid Allowed)

SUCTION BOTTLE ARTIST

E7024

Artist Suction Bottle is your on-the-go drink buddy. 400ml size bottle comes in turquoise color with high quality suction bottom. Certified High Food Grade Material Use. Product Size:24.4X9.1X7.6 cm
Packaging: Printed Paper Box

DOUBLE WALL MUG

E7001

250ML Double wall ceramic travel cup with silicone lid and grip. Ideal for hot beverages. Product Size: 7.8 cm Ø x height 14.5cm
Packaging: Black paper box





E70221

E70222



STONEWARE MUG

E7022

A two-tone color 12oz stoneware mug. Outer Matt Color of Blue or Black and inner shining white. Bottom is white color. Product Size: Top Dia 8cm, Height 10cm, Bottom Dia 6cm Packaging: Paper Box



E70192



E70199



E70191



Sublimation
Printing

VINTAGE MUG

E7019

12oz White Vintage shape sublimation mug, comes with colored rim that is back to the trend. Product Size:8.4cm(Dia)x 7.5cm (H) Packaging: Paper Box



DOUBLE WALL MUG

E7020

A very classy and unique design of 12oz Double Wall mug with Sublimation Printing. Matt White on the outer surface and Inner is Shining White. Product Size: Top Dia 8cm, Height 11.5cm, Bottom Dia 5.5cm Packaging: Paper Box



HAPPY MUG YELLOW

E7017

250ML ceramic mug with 3D spinning smiley object. It is patented in EU,UK,USA, India and China. Product Size: 8.5x9.5cm Packaging: White Paper Box

6oz MUG

E7007

Bone China uncoated mug 6oz. This mug is used for screen printing only. If you are a coffee lover then this is the mug for you! Put your espresso, coffee, or tea in this trendy 6oz mug and enjoy the moment Product Size:7.5x6.5cm diameter





E70353

E70352



BIGGY BOTTLE

E7035

1L Matte finish, BPA free (USA Tritan Original) and leak free drinking water with lock on the lid and press-to-open button. Has easy carry holder. Product size: 28.4height x 7cm diameter. Packaging: Paper Box

GLASSY

E7013

550ML Single Wall compartment fruit infuser glassbottle with silicon on body and cover. Product Size:24x6.5cm diameter Packaging: White Paper Box



TRITAN BOTTLE

E7010

Transparent 750ML Water Bottle with filter. The bottom has marking "TRITAN BPA FREE". While body has transparent Tritan, Lid with White & Filter transparent. Product Size:24X23cm diameter Packaging: White Paper Box



05

TECHNOLOGY

160	167	MAGSAFE CHARGER AND POWERBANK
164	172	POWERBANK
173	185	XOOPAR COLLECTION
185	189	MULTI-CHARGING CABLE
191	196	WIRELESS CHARGER
197	198	MOBILE STAND
198	198	CLOCK
199	202	USB
203	207	WIRELESS CHARGER SPEAKER
203	209	SPEAKER
210	210	TRAVEL ADAPTOR
122	212	CAR CHARGER AND ACCESSORY
213	215	ELECTRONICS AND ACCESSORY





Wireless Charging



Mobile Stand 2



Multi Charging



MAGSAFE



E31874



E31872



E31873



E31871

3N1 MAG TRIFOLD E3187

3N1 folded square 15W Magsafe Phone, 2.5W Watch and 3W Airpod Wireless Charger with no - stitching welding technology RCS PU material. Product Size: 25.5x6.7x0.9 cm; 8.5x7.8x1.5cm (folded). Packaging: FSC Paper Box



110W IT WORKS



E31864



E31861



E31862



E31863

3N1 MAG CHARGE E3186

- 
MAGSAFE
- 
Multi Charging
- 
Wireless Charging

3N1 Unique shape Foldable 15W Magsafe Phone, 2.5W Watch and 3W Airpod Wireless Charger with no - stitching welding technology RCS PU material. Product Size: 29.5x6.7x0.9cm. Packaging: FSC Paper Box



HOW IT WORKS



E14070



E14071



3N1 MAGSTAND

E1407

3n1 Magsafe wireless charger in a unique design. Comes with a stick-on round shape metal to help your non magsafe mobile magnetize on the charger. Input Type-C: 5V/3A 9V/2A 12V/1.5A. Output: 15W/10W/7.5W/5W. Output 1:2.5W (Apple iwatch) Output 2.5 :2W (TWS Type: Apple AirPods 2,AirPodsPro). Product Size: 8x10.5x10.6cm. Packaging: Paper Box



CAR MAGMOBILE

E1408



MAGSAFE



Wireless
Charging

Fast Charging Magsafe Car Wireless Charger with 15W Smart Foreign Object Detection (FOD) and air vent. Comes with extra stick-on metal for non-magsafe mobiles. Input:9V-2A /5V-2.4A . Output:9V-1.55A 15W/10W/7.5w/5W. Product Size: 8.5x6.5cm diameter. Packaging: Paper Box



- 
USB Charging
- 
Multi Charging
- 
Wireless Charging
- 
FAST CHARGING
- 
Indicator Light
- 
MAGSAFE
- 
10,000mAh Powerbank

MAGSAFE PD POWER

E2042

Slim and compact MagSafe 10,000MAH (38.5Wh) wireless Powerbank. Perfect size for magsafe mobiles. Product Size: 10.9x6.9x1.8cm. Packaging: Paper Box. Input: Type C 5V-3A, 9V-2A, 18W (Max). Output: Type C 5V-3A, 9V-2.2A, 12V-1.5A; USB-A 4.5V-5A, 5V-4.5A, 5V-4A, 5V-3A, 9V-2A, 12V-1.5A, 22.5W (Max)



- 
 Light Up
- 
 Powerbank
- 
 Wireless Charging
- 
 USB Charging
- 
 Multi Charging
- 
 Indicator Light
- 
 Suction Cup
- 
 Branding Area

POWER GO PLUS E2041

10,00mAh wireless powerbank with unique pattern design of black suction cups and built-in multi-charging cables. Light-up feature when engraved. Material: ABS + rubber. With LED indicator, li-polymer battery. Input 5V/2A (micro) and 5V/2.4A (typeC) / Output 5V/2A (USB). Self Charging time: 4hrs (2A adaptor). Life Cycle: ≥500times. Product Size:10.5x6.6x2.5cm Packaging: Black Box Packaging.



E20382

E203815

E20388

E203813



- 
 Multi Charging
- 
 Indicator Light
- 
 Suction Cup
- 
 Branding Area
- 
 Light Up
- 
 Powerbank
- 
 Wireless Charging
- 
 USB Charging

POWER GO E2038

8000mAh wireless powerbank with unique pattern design of black suction cups and built-in multi-charging cables. Light-up feature when engraved. • Material: ABS + rubber. With LED indicator, li-polymer battery. • Input 5V/2A (micro) and 5V/2.4A (typeC) • Output 5V/2A (USB) • Self Charging time: 4hrs (2A adaptor) • Life Cycle: ≥500times. • Product Size:10.5x6.6x2.5cm • Packaging: Black Box Packaging





100%^{OUT}



POWER BANK



E20391



E20390

MAG POWER

E2039

MagSafe 10,000MAH wireless Powerbank in Grade A li-Polymer Battery with ABS + Acrylic Battery. Product Size: 14.8x6.9x1.8cm. Packaging: Black Paper Box *Input:Micro 5V/2.1A Type-C:DC5V/3A-9V/2A-12V/1.5A*. USB Output 1-2 & Type C: DC 5V- 3A 9V-2A 12V-1.5A *Wireless: 15W / 10W / 7.5W/5W







E20431

E20432

E20433

E20434



USB
Charging



Multi
Charging



Wireless
Charging



Indicator
Light



Powerbank



Light Up



WIRELESS LIGHT UP E2043

Light Up 10,000mAh (37Wh) wireless powerbank in PU and ABS Material. Type-C Input: DC5V 2A. USB Output: DC5V 2.1A (Max). Wireless Charging Output: 5W. Product Size: 15X7.5X1.6cm. Packaging: Paper Box



PD POWER

E2040

20,000mAh Fast Charging High Capacity Powerbank. Its powerbank is a Panasonic Battery made in Japan, the same battery used for Tesla. This Powerbank can charge fastly with all your smart devices like Laptop, iPads, Tablets and Mobile Phones and others. Best for office, home, or travelling. • Product Size: 100x48x48mm • Packaging: Black Paper box • Capacity : 20,000mAh • Cell Type: Li-21700 cell(5000*4mah) • Micro Input:5V3A, 9V2A, 12V1.5A max18W • Lightning Input:5V/2A • USB Output 1(QC 3.0) :4.5V5A,5V4.5A,5V3A,9V2A,12V1.5A Max 22.5W • USB Output 2(QC 3.0) :5V/3A 9V/2A,12V/1.5A Max 18W • Type-C Input& Output (PD 3.0) 5V3A, 9V3A, 12V3A, 15V3A, 20V2.25A max 45W • USB Output 5 :2&1V/3A • Type-C output& USB Output 30 :1W max(type-c) 22.5W max(USB1), total 52.5W • Type-C output& USB Output 30 :2W max(type-c), 18W max(USB2), total 48W • Total 3 Output: 30W max(type-c), 5V/3A(USB Output 2&1) • Weight: 450g • Material: ABS+ Aluminium Alloy



LEATHER WIRELESS E2037

8000mAh Wireless Powerbank in a Unique PU Material. • Battery: Lithium Polymer. • Input: DC 5V / 1A / 3 output (2 usb output+wireless output): DC 5V / 1A-2.1A, • Wireless output: DC 5V / 1A, 5W. With led indicator for battery. • Product Size:13.4x7.1x1.6cm • Packaging: Black box Packaging





SQUID MAX LIGHT UP

E2018

Squid Max Powerbank with 7500mAh capacity. Portable external power bank for smartphone and tablet PC, Grade A Li-ion rechargeable battery, 2.1A output power provides express battery charging, dualUSB port, 2in1 charging cable, Over charge protection, Dustproof silicone suction pad, engrave texture surface. Logo light up. Product Size:8.9x6x1.8cm
Packaging: Black Paper Box



E20360

E20361



E20362

E20363



COMPACT POWER

E2036

10,000mAh Powerbank in a matte coating material. • Battery Cell Type: A grade Polymer cell. • Rated Input (Micro and Type C): DC 5V, 2A
• Rated Output: DC 5V, 2.1A max • Change Rate: 90% • Charging Time: 5-6H • Indicators: Digital Display Indicator • Protection/Function: short circuit, over charge, discharge, and over current protection.
• Product Size: 9.4x6.4x2.4cm • Packaging: White Paper Box



USB Charging RFID Safe



Indicator Light Card Holder



Powerbank

INE WALLET E3129

INE wallet made of genuine leather and Aluminum and brush material / Slimmest fashionable wallet with built-in slim battery / Four slots for cards, two slot including RFID protection / 3,000mAh battery capacity, charges up to 100 percent of your phone / Includes durable short keyring cables and one long cable for recharging / Battery Type: 406080 Rechargeable Li-Polymer 3000mAh(High voltage,High-density) / Accessories: Type-C to Type-C charging cable, Type-C to lightning charging cable, USB to Type-C charging cable / Product size: 104x76x9.5 (mm) / Packaging: elegant tin box

XOOPAR GO-GREEN

WHY WE NEED SUSTAINABILITY?



Earth's resources and wildlife are in danger.



Better systems exist that improves sustainability.



Sustainability practices also has a total impact on quality



WHAT DO WE DO ?

Xoopar has developed a measurement system to improve sustainable practices within the company management, product development and packaging.

It's called **XOOPAR SUSTAINABILITY CRITERIA**. Made of 4 main pillars; (1) **REUSABLE**, (2) **BIO DEGRADABLE**, (3) **RECYCLABLE**, (4) **RECYCLED**. Under this 4 categories Xoopar will focus to improve environmentally friendly system under a structured roadmap plan.





BIO FAMILY E5057

5 in 1 Wireless Fast Charging Station made of Eco-friendly bio-degradable material. Sleek design charger which Supports Qi enabled iPhone and Android phones, wireless charging earbuds and smart watch. Excellent for office, home and travel. Wireless Output Power (max)25W (Max) / Support 7.5W/10W Fast Charge / Charge Devices - 4(3*Wireless + USB A) /Output Interface/Total Power -3*Wireless, USB A/25W(Max) /Fast Charge Adapter Recommended -9V , 27W or above, QC or PD adapter /Accessories Included -USB A to Type C fast charging cable Product size: 62.6x32x7.6(mm), Packaging: Eco Box



MR. BIO CABLE E5046

Mr. Bio Eco-Friendly Multi Cable made from recycled cables and bio-degradable plastic. Has Adapter USB, Lightning USB, Type C, and Micro USB. Finishing is ABS Matt with 80mm cable. Max Output: 5v/2.4A(MAX) Product Size:150x32x12(mm) Packaging: Kraft Paper Sleeve

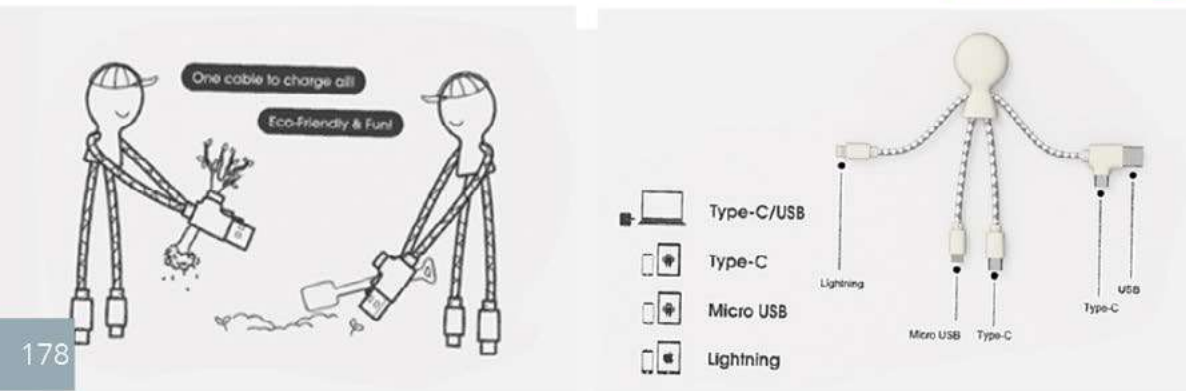

HOW IT WORKS



HOW IT WORKS

BUDDY CABLE E5066

All your charging needs in one! Charge all your smart devices, Android and iOS anytime and anywhere! Buddy Cable comes with dual input (USB and Type-C), and the helix chord is the unique part of the design that makes charging so convenient. Material/Finishing' TPE/Matt /Cable length 200mm / adapter -USB / Lightning / Type-C / Sync Charge Charge cable / Max Output DC 5V / 2.4A (Max) / Patent EU Design:007330113-0001 / Product size: 76x66x9 (mm), Packaging: Plastic pouch



POCKET 2 E5060

Ultra slim wireless mouse in a trendy design, made from recycled Wheat Straw. Has a built-in rechargeable battery and Light-up Branding space. Material: ABS, RF wireless mouse, nano receiver, Built in rechargeable battery. Buttons Number: Left, Right, Scroll Buttons. Transmission Distance: Up to 7m. DPI: 1200DPI. Working Way: 2.4G. Transmission. Product Size: 106x58x17(mm)



-  Recycled Material
-  USB Charging
-  Wireless Charging
-  10w Output Power
-  Indicator Light
-  Speaker
-  700mAh
-  Bluetooth

CORKLEY SPEAKER E5067

Eco-friendly wireless speaker with natural cork housing. Its BT 5.0 wireless speaker enables TWS stereo pairing, with high quality sound and strong bass. It has built-in battery that is wirelessly rechargeable. Enjoy your favorite playlist with Corkley Speaker! /Wireless Connection BT 5.0 /Transmission Distance Up to 10 m /Built-in Battery (mAh) Li-Polymer 700mAh (603040/Playtime up to 3 hours(max vol) , up to 6 hours (mid vol) / Battery Recharge- Wireless, Type C /Output Power 10W /Audio-Mono // Pair 2 speakers /Selfie Remote /Cork Outer Case, Biodegradable Inner Case / Accessories Included -USB A to Type C charging cable / Product Size: 98x98x85.5(mm) Packaging: Eco Box

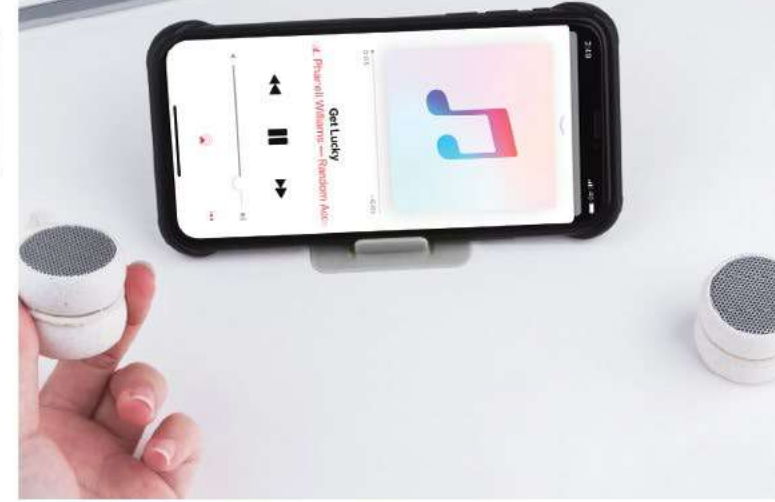

YOYO SPEAKER Wheat E6035

Yoyo Wireless Finger Speaker in wheat Version. Wireless Connection: Bluetooth / Transmission Distance: 10m / Battery Type: Li-Polymer / Capacity: 180 mAh / Playtime: up to 2 hours / Recharging Time: approx 1 hour / Battery Weight: 4.6g / Output Power: 3W / Audio: Mono with 2 pair of speakers and selfie remote. / Accesories: USB To micro USB charging cable. Product Size:34.4x34.4x31(mm) Packaging: Eco Box

- 
Recycled Material
- 
USB Charging
- 
Selfie Feature
- 
Output Power
- 
Indicator Light
- 
Speaker
- 
Power
- 
Bluetooth
- 
Distance

- 
USB Charging
- 
Selfie Feature
- 
Output Power
- 
Indicator Light
- 
Speaker
- 
Power
- 
Bluetooth
- 
Distance

YOYO SPEAKER E5050

Yoyo Wireless Finger Speaker in Metallic Version. Wireless Connection: Bluetooth / Transmission Distance: 10m / Battery Type: Li-Polymer / Capacity: 180 mAh / Playtime: yo to 2 hours / Recharging Time: approx 1 hour / Battery Weight: 4.6g / Output Power: 3W / Audio: Mono with 2 pair of speakers and selfie remote. / Accesories: USB To micro USB charging cable. Product Size:34.4x34.4x31(mm) Packaging: Black Paper Box



E50500

E50501

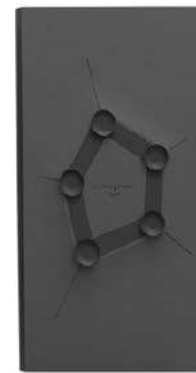

WIRELESS GEO DARK GREY E2034

GEO Portable Wireless Powerbank with 5000mAh capacity which supports all devices with built-in wireless charging function and has extra USB port. Made from ABS with matt finishing, Li-Polymer rechargeable battery (Grade A-charge over 500 times with full efficiency), Input DC 5V/2A, output DC 5V/2.1A, USB to micro USB charging cable and wireless output of 5W max. Unit weight of 140gm, charging time of up to 2.5 hrs while discharge capacity is up to 200%. Product Size: 12x6.9x1.6cm Packaging: Black Paper Box



GEO MOUSE PLUS E5038

New Geo Mouse Plus with Wireless Charging capabilities usable up to 10 days and Light-up. Material/Finishing is ABS/Matt. Wireless Connection: 2.4G and wireless / Transmission Distance: up to 10m / DPI: 1200. Product Size: 10.5x6.3x1.8cm Packaging: Black Paper Box

GEO SET PLUS

E8014

Geo Set Plus consists of Wireless Geo Powerbank 5000mah and Wireless Charging Slim Geo Powerbank. Box Dimension: 17.7x15x5cm
Packaging: Black Paper Box

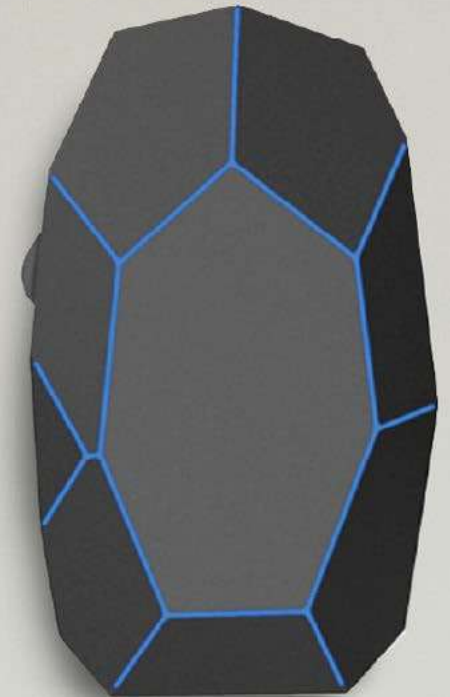

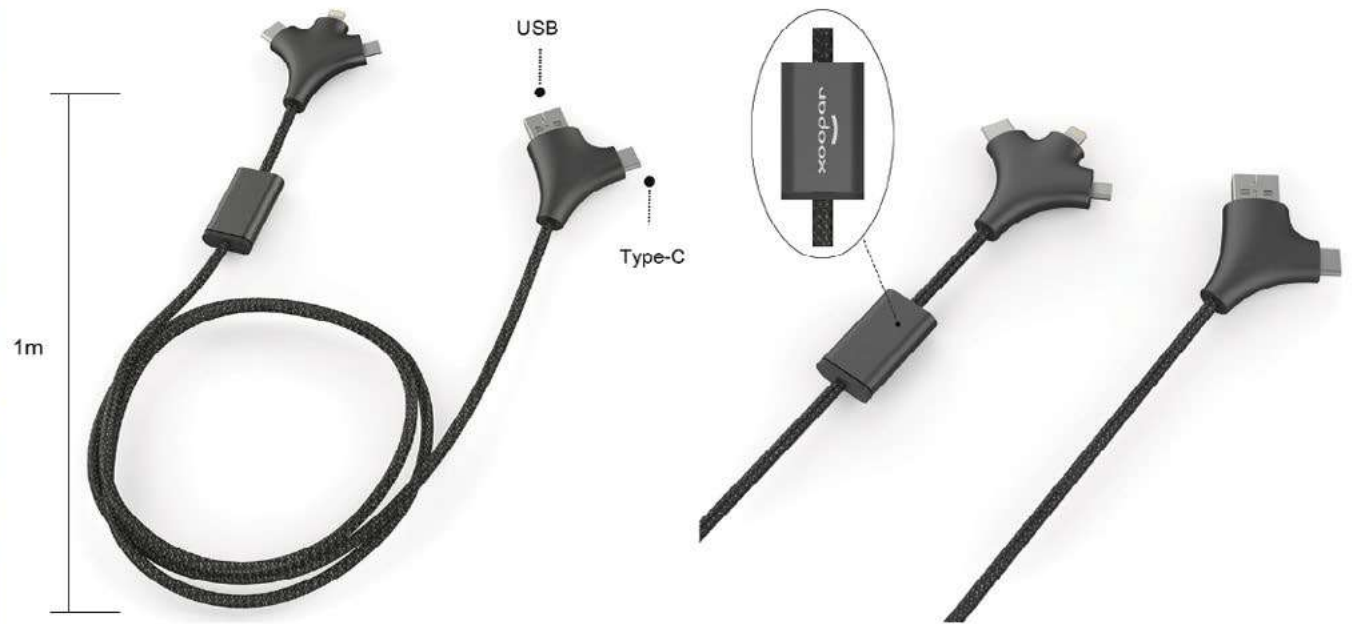
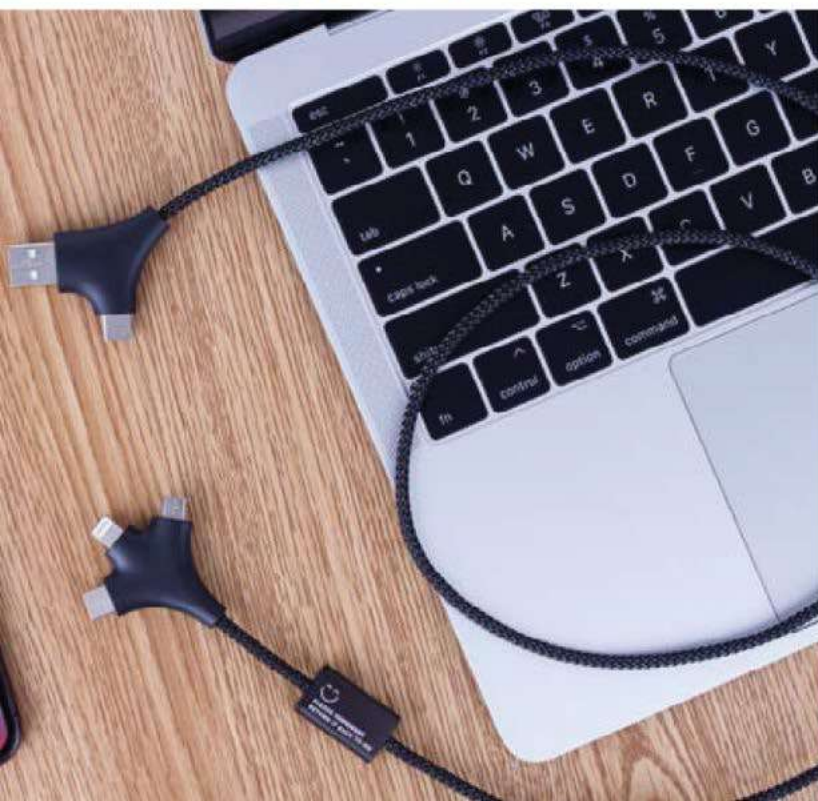

E50511



E50518

W CABLE E5051

W Shape 1m Charging Cable. Fabric cable that charges all devices and has 3 n 1 charging adaptor. Middle logo plate is the area for branding. (1) W One: USB to Type C+Micro+Lightning. (2) W Two: USB+Type C to Type C+Micro+Lightning. Type C and Micro USB adapter compatible with the most Android smartphone and tablet. Lightning adapter compatible with iPhone and iPad. Packaging: Paper box with Window



HOW IT WORKS



type-c



ios



micro



USB
Charging



E50480



E50481

3in1 LANYARD

E5048

Lanyard Charging Cable for IOS, Android, and Type C. Possible for sublimation printing. Input/Output: 5V Max to 2A / 1 x 2 in 1(micro USB+lightning) 1 x Type-C. Function: Only charging. Material: Dacron+ABS. Length: 90cm±3cm Packaging: Polybag



4-IN-1 PD CABLE E5073



Phone Stand 1M braided multi-charging cable and data transfer in aluminium alloy housing is a Power Delivery (PD) - quick and fast charging. Input : Type C + USB, Output : Lightning + Type C. Cable Size: 1M, Packaging: Paper Box



LIGHT UP CABLE

E5074

Light Up and fast charging nylon braided Multi-cables for iPhone/micro USB/Type-C. Light Color: White. Output : 5V/3A. Cable Size: 15cm. Packaging: Special Polybag



CHOOSE Trim Colors



E131411



E13141



E131412



E131417



E131414



E13149



E13142



E13144



E131418

MULTI CHARGING CABLE

E5021

Multi Charging Cable with micro pin*1, Type-C*1, Lightning*1(Apple USB), USB port *1. Fast Charging cable with data transfer function. Charge 3 devices at same time. LED trim illuminate logo printing logo. Product Size: 11.5x3.1x2.6cm Packaging: White Paper Box



SPINNER with charging cable

E1315

Anti-Stress Hand Spinner Device with 3 charging Cables. Includes: USB, Micro USB and Type C. Product Size: 7.6x7.6x1.3cm Packaging: Polybag





3 COLOR MODES



White



Natural



Warm



EASILY FOLDABLE



Wireless Charging

WIRELESS LAMP E5075

LED Table Lamp with 3 light options and Fast Wireless charging.
Input:9V-1.67A 5V/2A . Wireless charger Output: 9V/1.2A 5V/1.5A.
Product Size: 8.35x18.2x48.5cm. Packaging: Paper box



BLUETOOTH CONFIGURATION TO WORK ON IPAD/PHONE



- Bluetooth
- 600mAh Powerbank

WIRELESS MOUSE **E5072**

Dual Connection Bluetooth or Wireless mouse with 600mAh rechargeable battery. Can work up to 10-6M away from PC and compatible with Bluetooth 3.0 up to Bluetooth 5.0 version. Product Size: 11x5.6x3cm. Packaging: White Paper Box



E50681

E50680

iWIRELESS PAD E5068



Wireless
Charging

Dual coil wireless charger for mobile phone, airpod and iWatch charging. With Type C and Micro USB input. Made in ABS Material. Product Size: 10cm dia x 0.8cm. Packaging: Paper Box
 *Input:9V-2A/5V2A *Output: (15W MAX Watch output: (5W MAX)
 Earphone case output: (5W MAX) *Transmission distance:10--5mm
 *Frequency:205-110KHz *Conversion Rate:73%



Certified



— QI WIRELESS STAND

E5040



Wireless
Charging

Mobile
Stand 1

Fast
Charging

10W Certified Wireless Charging Pad. Rated Input: DC 5V/2A, 9V/1.8A / Wireless Output: DC 5V/1A, 9V/1.1A (10W max) Wireless Change Rate: $\geq 72\%$. Indicators: 1 LED indicator. Protection Function: short circuit and over current protection. Product Size: 13.6x7.2x1cm Packaging: White Paper Box



- 
 Mobile Stand 1
- 
 Wireless Charging
- 
 Fast Charging
- 
 Indicator Light

WIRELESS GO-ROUND E5049

Wireless Charger which has a movable top part to adjust position of the mobile when charging with LED light indicator. Has an anti slip wireless charging pad to ensure safe and secure hold of the mobile. Input: DC5V/2A, 9V/1.8A, 12V/1.5A / Output: 5W, 7.5W & 10W (fast charge) / Working distance: 8-0 mm / Charging efficiency: Approx. 70-%60%. Product Size:9cm(Dia)x6(H)cm Packaging: Paper Box



E50470



E50471



WIRELESS CABLE CASE E5047

All your cables and charging needs in one card-sized kit. Has sim card remover, nano and sim card holder, lightning USB, android USB, Type C, and USB Port adaptors. A handy and easy-to-carry item for all your everyday tech requirements. Product Size:8.5x5.7x0.5cm Packaging: Paper Box



NOTE: CHARGER NOT INCLUDED



Wireless Charging Mobile Stand 2

MAG-FOLD STAND E5069

Foldable mobile/tablet stand. Compatible for insert original Magsafe charger. Easy to adjust height and angle. Can be folded for easy carry. With large flat base best for logo printing. Certificates: RoHS, Prop65. Product Size: 6.7 x 11 x 3.2cm (folded). Packaging: Paper box



ALU MOBILE HOLDER E1351

Foldable mobile phone stand in Aluminum material. Product size 9.7cm x 7.3cm Packaging: paper box



Mobile Stand 1



E135113



E13511



E135118



DIGITAL CLOCK E5033

Digital clock with calendar. Includes backlight, snooze, alarm and indoor temperature. It has bamboo pattern as well. Battery: AAAx2 pcs(not included). Product Size:13.8x9x3.5cm Packaging: White Paper Box.



E10214

E10212

E10211

E10213



Flash Drive

BOB USB E1021

Paper Weight bob 2.0 USB with 32GB capacity comes in unique colors made from recycled ABS material. Mirror finish effect when engraved. Read speed 8-7MB/s, write speed 3-2.5MB/s. Product Size: 5.2x2.9cm diameter. Packaging: Paper Box

KEYHOLD USB

E1042

Keyhold 32GB USB in gunblack metal finishing and special PU material. Reading speed: 2.0. Product Size: 7.4x2.1cm
Packaging: White Paper Box



Flash
Drive



E10422

E10421

E10423

E10424



E10430



E10432

SLIM LIGHT USB BLACK 32GB E1043

Slim Light USB 32GB in a metal material with logo engraved light up feature. Reading Speed: 2.0. Product size: 6cm x 1.25 x 0.5cm. Packing: White Paper Box



MINI USB GUNBLACK 32GB E1044

Gunblack Color Mini USB in 32GB Capacity, 2.0 reading speed. Material: Aluminum+Silicone Rubber. Product Size:4.5x1.2x0.5cm (USB Size Only) Packaging: White Paper Box



BAMBOO USB 16GB E1040

A bamboo made USB cover with 16GB capacity and 2.0 Reading Speed. Has a metal keychain for easy keeping and hold. Product Size: 4cm x 2cm x .9cm excluding the keychain Packaging: Paper Box.



LIGHT UP USB 32GB E1025

Light Up USB 32GB with white body. Reading Speed: 8M/S. Product Size: 5.2x3.13x2.63cm Packaging: White Paper Box



E10261

E10268



USB CLIP 16GB E1026

16GB U-disk USB flash aluminum roller ball pen with touch stylus with blue ink. Product Size: 13.5cm length Packaging: White Paper Box



Wireless
Charging



Fast
Charging



Universal
Standby



Bluetooth



Light Up



Speaker

WIRELESS SPEAKER E5056

3W Speaker with 10W Wireless charger and Light-up Logo. Functions: Phone Holder, Wireless Charger, Bluetooth Speaker. Can operate up to 10M distance diameter. Frequency response: 20Hz-20KHz. Product Size: 11.3x8.4x7.6cm Packaging: Paper Box



Mobile Stand



Wireless Charger



Gradient Lamp



Touch Control



NIGHT LIGHT SPEAKER

E5079

'Light up Bluetooth speaker with wireless charging. Product Size:13.75x11x9.2cm Packaging: Paper Box Bluetooth Versions: 5.0 Loudspeaker Output: 5W Wireless Charging Output: 10W Battery Capacity: 1200mAh Operating Distance: <10 meters Frequency Range: 20Hz20-KHz Signal to Noise Ratio: > 75dB Distortion: <%1



-  Wireless Charging
-  Mobile Stand 1
-  Light Up
-  Speaker



Wireless Mobile Light Up Speaker
Charging Stand 1

NIGHT LIGHT SPEAKER E5080

Light up Bluetooth speaker with wireless charging in recycled wheat straw material. Product Size:13.75x11x9.2cm Packaging: Paper Box Bluetooth Versions: 5.0 Loudspeaker Output: 5W Wireless Charging Output: 10W Battery Capacity: 1200mAh Operating Distance: <10 meters Frequency Range: 20Hz-20KHz Signal to Noise Ratio: > 75dB Distortion: <1%



LIGHT UP SPEAKER E5013

Suction phone holder is a 3W bluetooth speaker with 10W wireless charger. Very great to advertise brand as one side has light up when engraved and with plate for printing. an operate up to 10M distance diameter. Frequency response: 20Hz-20KHz. Product Size: 6.3x6.3x7.3cm Packaging: Paper Box



Speaker



Bluetooth

MIMI BT SPEAKER

E5077

Sport bluetooth 3W speaker has built-in microphone and hands-free. Standby time is 4-2days and talk time can be 12-5hours. Can operate up to 10M distance diameter. Frequency response: 280Hz-16KHz. Product Size: 4x8cm Diameter. Packaging: Acrylic Box



3 Sides Light Up Logo



MINI SPEAKER

E5076

3 sides light up 3W mini speaker which can be connected with each other to amplify sound effect and can be used as a selfie tool. Can operate up to 10M distance diameter. Frequency response: 20Hz-20KHz. Product Size: 4.1x4.1x4.6cm. Packaging: Paper Box



Speaker



Light Up



Bluetooth





E50251



E50252



E50253



E5025

TRENDY WIRELESS SPEAKER



Bluetooth



Speaker

Bluetooth wireless stereo speaker supports for use with iPhone, iPad, Samsung, Android device and other Bluetooth enabled devices. Powerful stereo speaker with built-in amplifier, provide crystal and clear sound performance. 400mAh rechargeable lithium-ion battery enables you take your music anywhere for hours of playing. Accessories includes: USB charging cable. Material: ABS and electronic components. Product Size: 18.4x4.4x10.4cm Packaging: White Paper Box



Bluetooth



Speaker



E50192

E50195

E50199

E50196

E50191

DIVENAMIC SPEAKER

E5019

Water-Resistant Bluetooth Speaker with flexible mount. Ultra-portable speaker for any adventures – it has a built-in microphone and its unique flexible “tail” mount is designed to be completely universal in any situation. Easily fix Divenamic on a bike wheel, shower head or a bag and enjoy music whenever you want! Material: ABS plastic + silicone. Battery: 250mAh, Li-Polymer. Working time: +3 hours Charging time: ~1 hour Built-in charging cable: USB to micro USB. Product Size: 20x5.3x3.1cm Packaging: White Paper Box



E50440



E50441

SLIM ADAPTOR

E5044



Multi Charging

Material: PC & copper. Voltage: 250-100Vac. Fuse: 2 fuse. USB: 2 USB: Certificate: CE,FCC,ROHS Product Size:8.9x6x2.3cm Packaging: White Paper Box





 USB Multi
 Charging Charging



TRAVEL KIT GREY

E5034

Travel Adaptor Kit has A.) World Travel Adapter with 2 USB charger, unit dimension: 6.5x6.5x5cm unit weight: 108gm input: 250-100V fuse rating: 6.3A USB output: 5V/2.1A max plug types: UK/AUS/EU/US. B.) 2 USB Car Charger, unit dimension: 3x3x7.9cm unit weight: 24gm input: 12V USB output: 5V/2.4A maximum. C.) Universal Charging Cable, length: 100cm rating: 3A female connector: micro USB + lightning. All these 3 items comes with a non-fabric pouch having a size of 14.3x12cm. It is also presented in a box packaging with dimension: 21.3x12.4x6.5cm





 USB Wireless Fast
 Charging Charging Charging

ROBOTECH CHARGE

E1405

10W Car Charger dashboard phone holder with Smart Sensor Auto-Clamping fast charging car phone holder. Material: Fabric+ABS+metal+silicone/ Input : 9V/1.67A Output: 9V/1.2-1.0A/ Charging efficiency: 73 -%67%max/ Working frequency:205-110KHZ/ Charging distance:8-0mm/ Sensor Distance: 10-0cm / R/L Clamping On/Off time:3"/ R/L Clamping Support Width: Min 60mm, Max 85mm./ USB cable: Type C/ Protection: FOD(Foreign Objection Detection, Over Voltage Protection, Over Current Protection, Over Temperature Protection(70degree))/Certificate: CE, RoHS,FCC. Product Size:12x10cm Packaging: White Paper Box



USB
Charging



Multi
Charging

DUAL CAR CHARGER

E1310

Dual USB car charger. ABS material. Product Size: 6.2x5x2.1cm
Packaging: White Paper Box



E14068



E14061

CAR MOBI

E1406

Gravity Car Mobile Phone Holder.
Material: Aluminium alloy
+ABS+metal+silicone. Feature: Arm
with lock R/L. Clamping Support Width:
Min 66mm, Max 85mm. Product
Size: 11x7.5cm Packaging: White Paper
Box



Phone
Holder



E13280



E13281



Bluetooth

FIND ME! E1328

Anti Loss Gadget. Working distance: 50meters. Compatible Device: Android and ios; IOS8.0 or newer and Android 4.3 or newer
App: "Track Fast"(free of charge). Product Size:3.6cm Diameter
Packaging: Paper Box Packaging,



E14031



E14030

BLUETOOTH ADAPTOR E1403

Bluetooth adapter make all wired headphone to wireless, it suits all smart phone, traditional household speaker, it's the best mate to new iPhone7, android phone, speakers. Material is ABS, 1pc User Manual/ 1pc Charing Cable/1pc 3.5mm Audio Cable. Product Size: 5.3x3.5x1cm
Packaging: White Paper Box



Bluetooth



HANDY SCALE E5043

50 Kgs Maximum Capacity Weighing Scale. High Definition blue film screen with white LCD uniquely designed with coiled weaved belt. With On Hold Function, Soft touch silicone handle and free 2x3V lithium battery. Product Size:11x3.6x4cm Packaging: White Paper Box

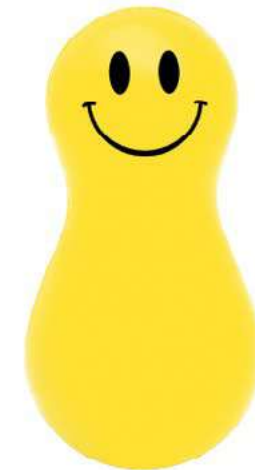

HAPPY STRESSBALL E1322

PU Stress Tumbler in yellow color and with smiley printing. It has magnetic head and has additional paperweight at the bottom. Packaging: Polybag



DUSTMATE E1342

Dustmate Computer cleaning tool with brush for the keyboard and wiper for the screen. ABS casing. Product Size:14x6.5x7.5 cm. Packaging: Paper box



TAPE MEASURE E1312

Tape Measure with easy readability with 16 mm wide blade. Metric and Imperial 3.5m/12ft Case designed to fit comfortably in your hand. Clear coat blade protection-more durable markings. One metal C clip easy to carry. One plate for printing logo and one trim to make logo outstanding. Color: white Certificates: ROHS. Product Size:5.8x5.4x2.8cm Packaging: White Paper Box



BULBY STRESSBALL E1341

Anti-stress in light bulb shape. PU material. Product Size: 9.5X5.5cm Packaging: Polybag



06

WRITING

218	220	PEN SET
221	232	METAL PENS
233	237	ALUMINIUM PENS
238	241	ANTI BACTERIAL PENS
243	246	ECO PENS
238	247	PLASTIC PENS



E40501





EXQUISITE PEN SET E4050 / E4051

VIP Gift Pen Set consisting of roller and ballpoint pen is made from brass material and packed in a high quality box. Looking elegant in the black or white black body and rose gold or silver accent with carved designs. Mirror Effect When Engraved. Pens Size: 3.7x1.25cm. Product Size (with box): 20.8x9.8x4.3cm.



HANDY PEN PLUS

E4036

Twist pen with hand shaped holder with brass material pen stand, finishing is mainly made from matte black chrome plated. Brass pen with an iron clip. Etched middle barrel has finish material of matte black chrome plated w/black lacquered. Rest of pen parts has finishing of matte black chrome plated. Parker type ballpoint blue ink refill. Weight: 226gms. Product Size:7.2x3.1x2.6cm Packaging: black box.





E404716



E40471

E40472

MODISH PEN E4047

Ballpoint pen made from brass and Aluminium roll which barrel is drawbench technology. Product Size: 13.63x1.2cm. Packaging: Polybag.



UNIQUE PEN E4048

Ballpen and Pencil all in one. Pen top is drawbench technology and tip is plating. Pen material is brass and Aluminium roll. Product Size: 13.6x1cm. Packaging: Polybag



CHARM PEN

E4052

Black spray paint barrel with Rose gold accent Ball Point pen in brass and stainless steel material. Mirror Effect when engraved. Product Size: 13.75x1.2cm. Packaging: Polybag.



GLAMOUR PEN E4049

Ball Point pen with carved designs made from brass material. Product Size: 13.75x1.2cm. Packaging: Polybag.



ALLURE ROLLER PEN BLACK E4044

Octagon sided roller point luxury metal pen in a matt paint in the barrel and gunblack clip and tip. Product Size: 13.5cm height, 1cm diameter.



ALLURE PEN E4043

Octagon sided twist ball point luxury metal pen in a matt paint in the barrel and gunblack clip and tip. Product Size: 13.7cm height, 1cm diameter. Packaging: Polybag.



E40414

E40411

E40413

E40412

POSH PEN

E4041

Posh Metal Pen in a special PU Material with mirror finish in the clip part.
Product Size: 13.9 Height x 1.2 diameter. Packaging: Polybag.



E40453

E40454

E40452

E40451

SLIM PEN

E4045

High Quality Slim Metal Twist Pen Covered with Special PU Material in
Blue Ink. Product Size: 13.7cm length Packaging: Polybag.



E40420



E40421

LUSH PEN E4042

Matt Lush Metal pen with mirror engraving finish. Product Size: 13.9 x 1.2cm. Packaging: Polybag.



STYLISH PEN

E4033

High Quality Metal Twist Pen Covered with Special PU Material in Blue Ink. Product Size:14cm length Packaging: Polybag.

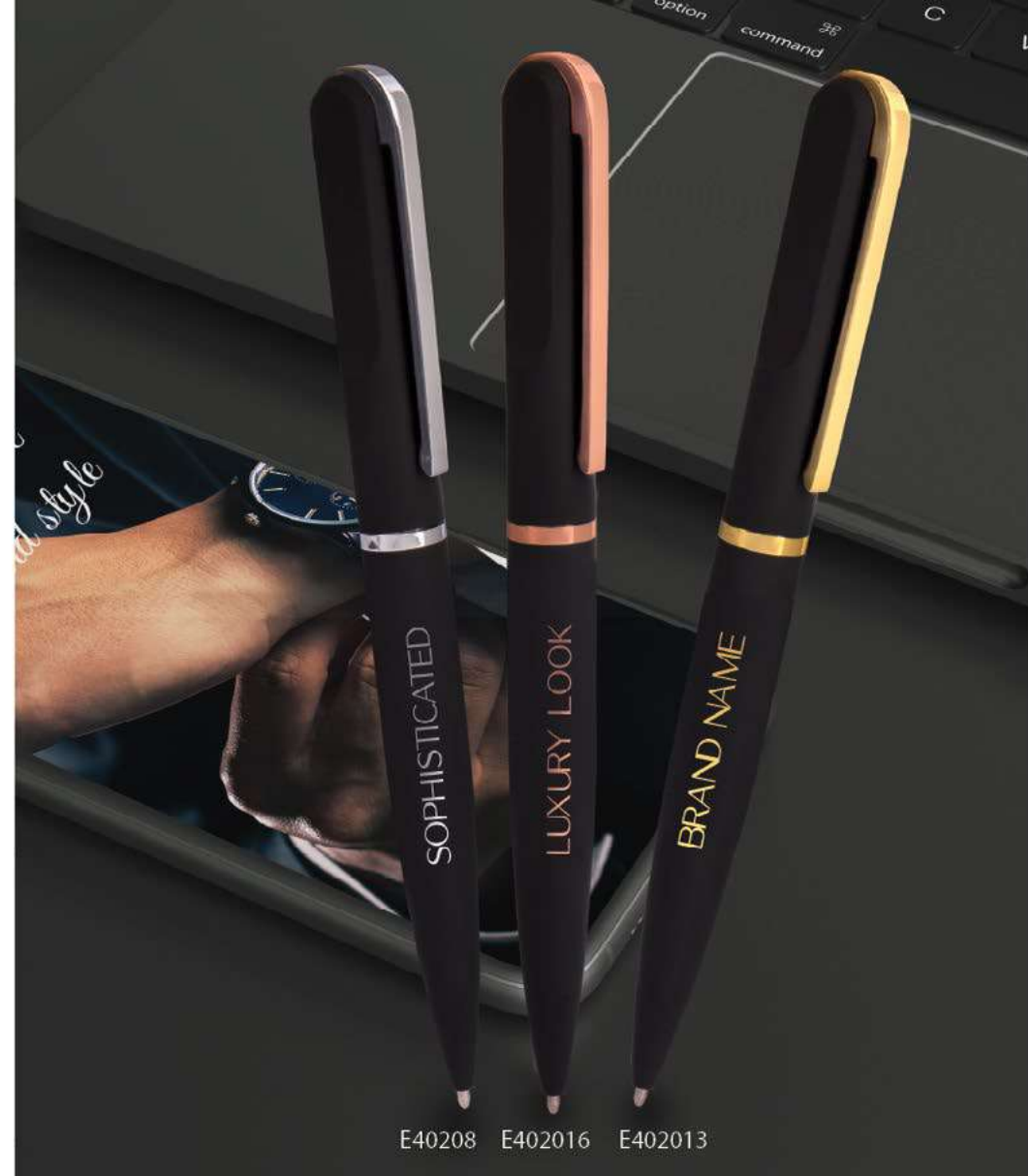

METAL PEN

E4020

Stainless and ABS pen with rubberized coating, chrome clip and plating under. Blue ink. Product Size:14.7cm length Packaging: Polybag.



GUNNY PEN

E4031

Twist gunblack metal pen with blue ink. Product Size: 13.5x1.28cm
Packaging: Polybag.



ELEGANT PEN

E4035

Twist Gunblack Metal Pen with Blue Ink. Product Size:13cm length
Packaging: Polybag.



METAL TOUCH PEN E4021

Stylus Ballpen with chrome plating under the lower barrels. Blue ink.
Product Size: 14cm length Packaging: Polybag.



CLIPPY PEN E4023

Metal Ballpen, Stainless Iron & ABS. Refill: Cross Standard, metal, 1mm,
Chinese tip. With rosegold engraving effect. German Blue ink. Product
Size:14cm length Packaging: Polybag.



LUXY PEN

E4029

Twist matt chrome metal pen with blue ink. Product Size:13.8x1.25cm.
Packaging: Polybag.



LUXY ROLLER PEN

E4046

Roller matt chrome metal pen with blue ink. Product Size:13.8x1.25cm.
Packaging: Polybag.



LUXY SET

E4028

A Set of matt chrome metal pens and a roller pen with size: 13.8x1.25cm. There is an additional bottom layer for your item of choice. Ink: Blue Parker. Ball pen has a unit weight of 32gm while the Roller pen has weight of 35gm. Product Size:14x1.25cm Packaging: Elegant Hard Paper Box



E40343



E40344



E40342

DELUXX PENSET E4034

Aluminium Ball Pen & Roller Pen in a Set. Mettalic Lacquered Body with Chrome Bright Parts in Blue Ink. Product Size:18.5x6x2.5cm Packaging: Paper Box Matching Color with Paper Sleeve.

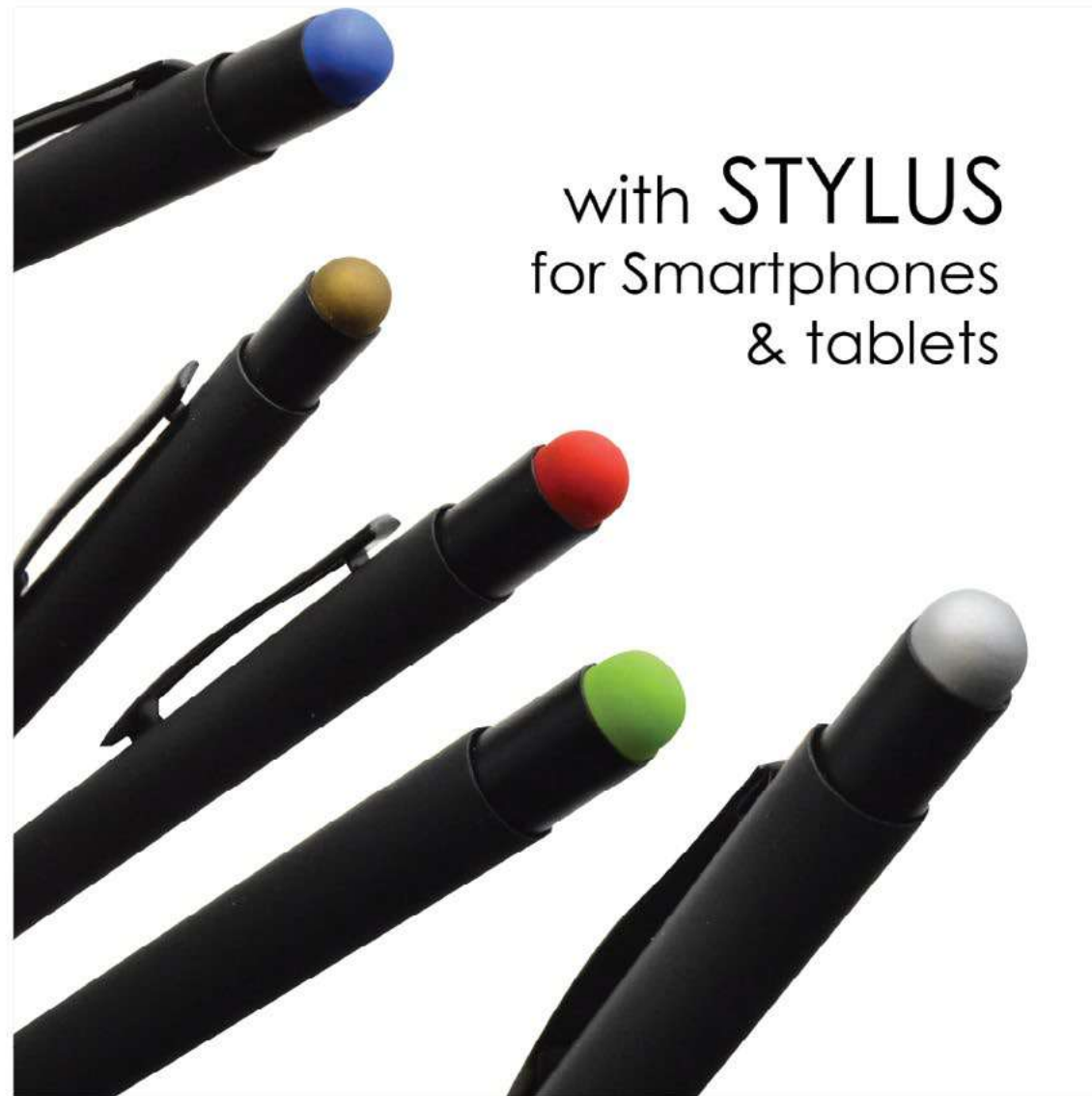

with **STYLUS**
for Smartphones
& tablets

LONY PEN E4027

Aluminum material push pen with a body made from black rubber coating. It has a colored Touch Stylus and with colored mirror engraving effect. Blue ink. Product Size:14.1 cm length Packaging: Polybag.

ALU PUSH PEN

SLIM STYLUS PEN



ALU PUSH PEN

E4019

Aluminum Ballpen, silver lower barrel & ousher with black rubberized upper barrel and metal satin clip. Loaded with blue parker ink. Unit weight: 18G. Product Size: 14.3cm length Packaging: Polybag.

SLIM STYLUS PEN

E4006

Twist metal pen with stylus. 1.0mm black ink. Product Size: 13.7cm length Packaging: Polybag .



ALUMINUM PEN E1212

Twist metal pen with stylus. 1.0mm black ink. Product Size: 13.7cm length Packaging: Polybag .

E40261



E40262



E40267



E402620



E40268



6 in1 PEN

E4026

Multi-funtional twist ball pen made from aluminum material in which can also be used as Touch Pen, Ruler, Screen Cleaner, Phone Holder and as a Screwdriver. Blue ink. Product Size:15.5cm length Packaging: Polybag.

ANTI BACTERIAL

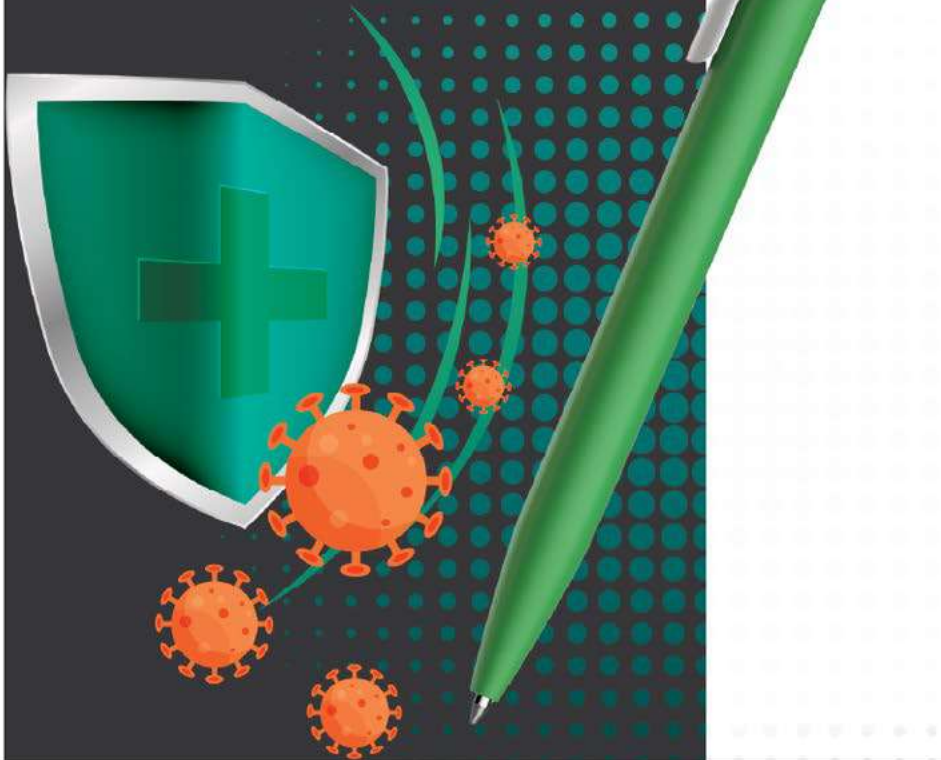

ANTI-BAC PEN E1224

An anti-bacterial push type pen with white clip. Product Size: 14cm, 1.1cm diameter. Packaging: polybag.



CLEAN STATIONERY SET

E1221

An anti-bacterial stationery set with 1 ball pen, 1 pencil, 1 ruler and 1 eraser. Pen ink is 1mm blue color. ISO22196 certified. Product Packaging Size: 16.5cmx1.25x1.3 cm Packaging: Anti Bacterial PP Box.



CLEAN PUSH

E1223

Push Type Antibacterial ballpen with solid white barrel, clip and button. 1.0MM blue ink. ISO22196 certified. Product Size: 14cm, 1.2cm diameter. Packaging: polybag.



CLEAN TWIST

E1222

Matte Finished Twist Anti-Bacterial Ball Pen with solid white barrel and clip. 1.0MM blue ink. ISO22196 certified. Product Size: 14.5cm, 1.1cm diameter. Packaging: polybag.





SPRAY PEN BLACK E12191

Spray plastic pen with 3ML alcohol that can be use for 40times spray. Blue ink color. Product Size:15.5 cm length Packaging: polybag .



SLIM SPRAY PEN BLACK E12201

Slim Spray plastic pen with 3ML alcohol that can be use for 40times spray. Blue ink color. Product Size: 15.5cm length Packaging: polybag .



NATIONAL DAY PEN E1218

UAE National Day Pen design with plastic material and silicon grip. Push Pen with Blue Ink. Product Size:13.6x0.5cm. Packaging: Polybag.



PLASTIC PEN WHITE E1209

Push type plastic ball pen, chromed button inner part and tip. 1.0mm blue ink. Product Size:14.7x0.9cm Packaging: Polybag.



E122514

E12259

E12254

E12252

E12251

BOTTLE PEN

E1225

Push pen from Recycled Pet Bottles (RPET) with colored transparent body in blue ink. Product Size: 14.2cm, 1.1cm diameter. Packaging: polybag.

E12164

E12160

E12162



RPET PEN

E1216

Push Action Ballpen with Clip made of Recycle PET Bottle Material. Plastic Parker Refill in Blue Ink. Product Size:14cm Length. Packaging: Kraft Paper Sleeve.



BAMBOO PEN E1227

Bamboo body push button pen. Size: 14x1.1cm diameter. Packaging: Polybag.





BAMPEN

E1226

100% eco-friendly and biodegradable push button ballpen. Made from Bamboo barrel and wheat straw tip, clip and button with Blue ink. Product Size: 14cm, 1.1cm diameter. Packaging: polybag.



E12143

E12141

E12148

E12142

SCREEN PEN SILVER

E1214

Ball pen with several functions such as screen cleaner and with active stylus. Comes in vivid colors twist action pen. Blue ink. Product Size:14.1cm length Packaging: Polybag.

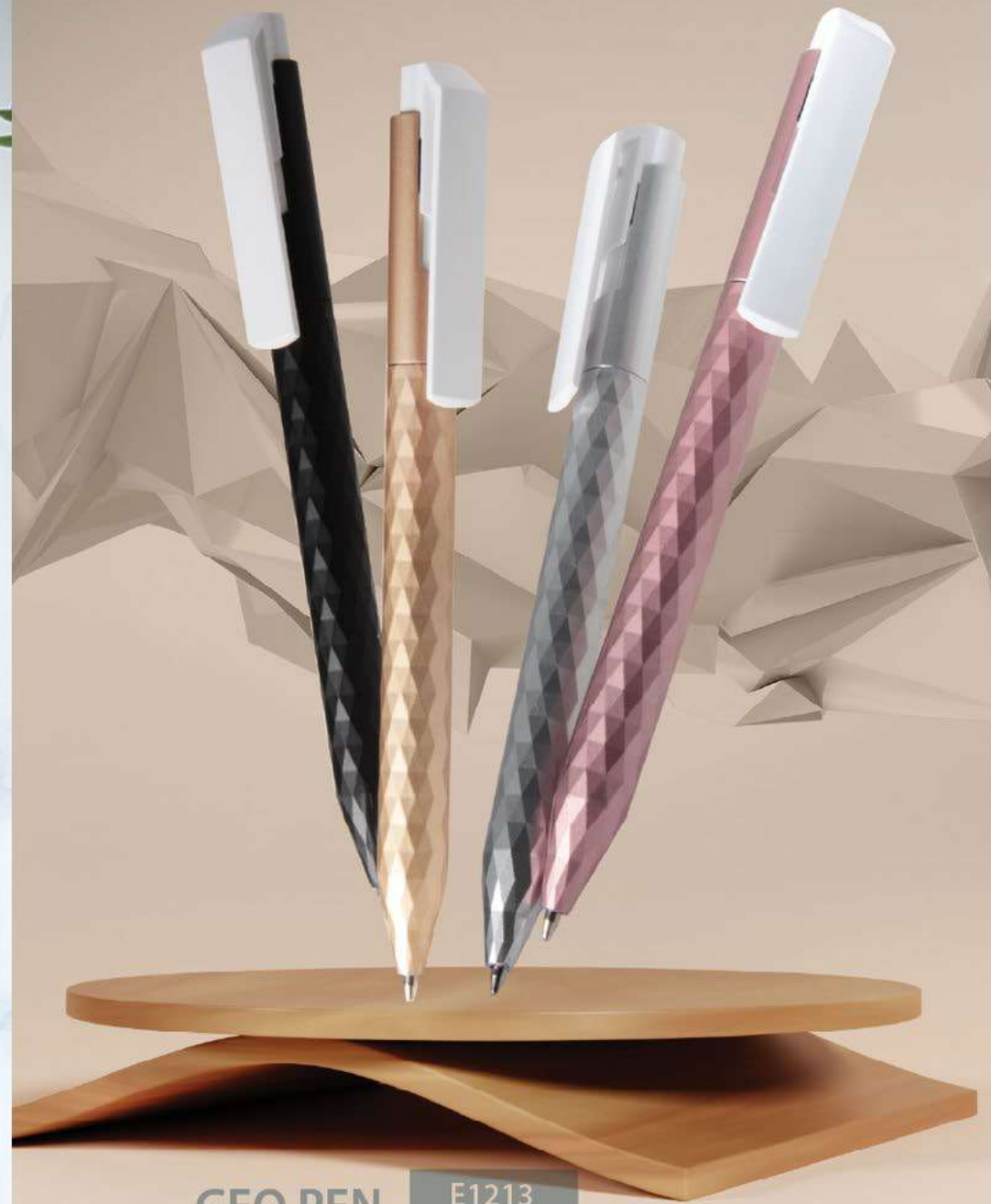

GEO PEN

E1213

Push pen characterize by 3D triangular structure on casing surface. It includes a big clip and jumbo parker refill. Blue ink. Product Size:13.8cm length Packaging: Polybag.

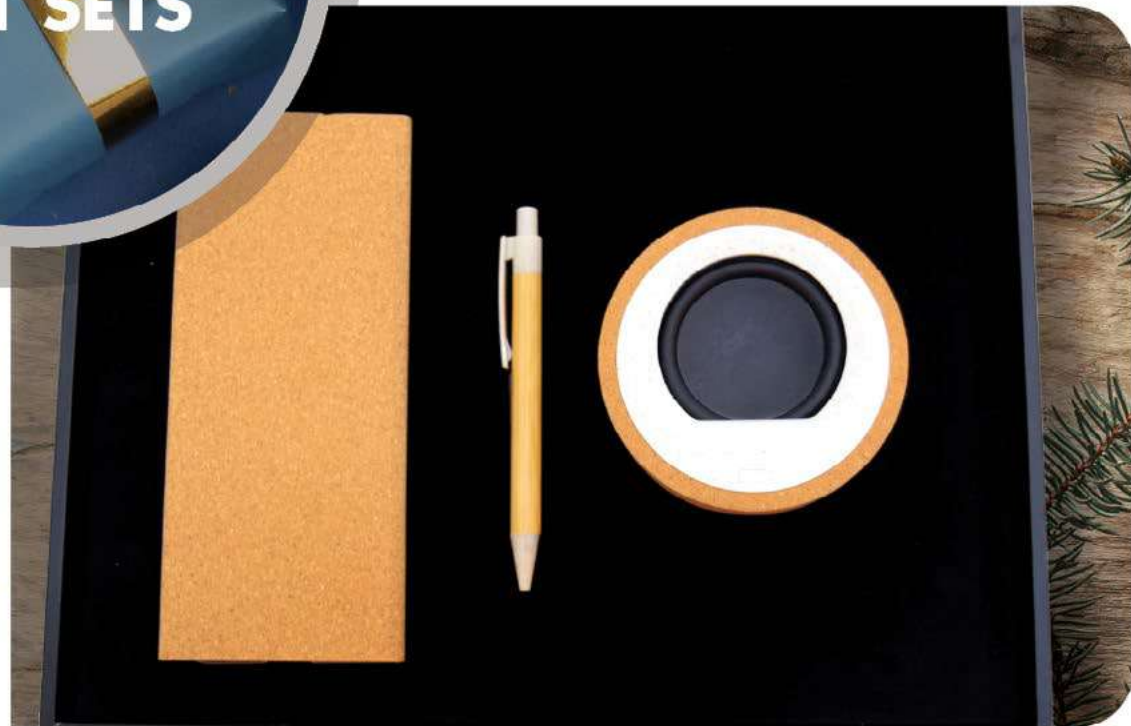

07 GIFT SETS

250	257	READY SETS
258	276	SUGGESTED SETS
277	279	PACKAGING





E31523



E31524



E31522



E31521



GIFTI BOX ORGANIZER E3152

A perfect desktop gift that has a frame with 13 sheets calendar on it and a 4cm height drawer with finger hole to open from front side. Drawer comes with A5 Soft PU Lined notebook 100 sheets and 1.5cm velvet EVA foam where you can do diecut for the items that you want to add. It also includes 2 dividers that you can use as separator in the drawer turned storage. It has yellow sticky note: 10 x 7.6cm & 5 x 7.6 cm (25 sheets each pad), 5 colors PET Flag: 1.2 x 4.5 cm(25 sheets each pad). Product Size: 22.1 x 17.3 x 6.3cm; Packaging: Paper Sleeve





Ergonomic
Angle Adjustable



ALU TECH SET E8017

Modern and Slim Gadget accessories made in Aluminium material consist of Laptop stand, magnetic laptop phone holder, and mobile stand for desk that is compatible to mostly laptops and mobiles. Product Size: 27.5x24.7x4.7cm (box)







E80163



E80164



E80161

PRIME SET E8016

A perfect set to anyone at anytime. Special PU material made into A5 Notebook with 96 sheets of 70g ruled ivory paper and pen loop, Metal Pen with PU cover on the barrel and spray paint on the clip side & Keychain in PU material and electroplate gun metal on the holder. Packed into a matching color hard paper box. Product Size: 24x24x2.5cm (box)



E80162



CORKNOTE SET E6051

Nice and sleek design for a sustainable set that consist of A5 notebook in cork & linen cover with 96 sheets 70g ruled ivory paper & pen loop and cork ballpen packed in kraft paper box. Product Size: 23.5x19.5x2cm (box)



CLASSIC SET BLACK E8012

Functional Gift Set made in PU composed of Notebook (Size: 14.2x20.8cm, 80 GSM, 96 sheets cream paper with ribbon and pen holder at the button closure, the spine has silver metal strip), Business Card Holder, Key Ring. Packing will be a hard paperboard box with EVA inside.

SUGGESTED SETS

Click



GREY SET

Suggested Set is not a ready set. Minimum Order Quantity is 100pcs. Items in the box can be replaced with any similar or any item of your choice. There are 4 color options for this: GREEN, BLACK, BLUE AND GRAY.

E11173 E31503 E13523 E40453



LIGHT UP SET

Suggested Set is not a ready set. Minimum Order Quantity is 100pcs. Items in the box can be replaced with any similar or any item of your choice.

E11173 E20431 E5074 E10430



BLUE SET

Suggested Set is not a ready set. Minimum Order Quantity is 100pcs. Items in the box can be replaced with any similar or any Item of your choice. There are 2 color options for this:BLUE AND BLACK.

E11172 E31352 E13523 E40482

BLUE TECH SET

Suggested Set is not a ready set. Minimum Order Quantity is 100pcs. Items in the box can be replaced with any similar or any item of your choice. There are 4 color options for this: GREEN, BLACK, BLUE AND GRAY.

E11172 E31462 E40412 E10422





ON THE GO SET

Suggested Set is not a ready set. Minimum Order Quantity is 100pcs. Items in the box can be replaced with any similar or any item of your choice.

E1317 E50440 E50470 E1025



LUMINOUS SET

Suggested Set is not a ready set. Minimum Order Quantity is 100pcs. Items in the box can be replaced with any similar or any item of your choice.

E31781 E5076 E4021 E10430



EMPLOYEE SET

Suggested Set is not a ready set. Minimum Order Quantity is 100pcs. Items in the box can be replaced with any similar or any item of your choice. There are 4 color options for this: GREEN, BLACK, BLUE AND GRAY.

E70413 E20433 E40483 E10213



VIBRANT GREEN SET

Suggested Set is not a ready set. Minimum Order Quantity is 100pcs. Items in the box can be replaced with any similar or any item of your choice.

E20434 E40344 E31424 E32014





ROBO SET

Suggested Set is not a ready set. Minimum Order Quantity is 100pcs. Items in the box can be replaced with any similar or any item of your choice.



E7042 E5072 E2040



TRAVEL KIT

Suggested Set is not a ready set. Minimum Order Quantity is 100pcs. Items in the box can be replaced with any similar or any item of your choice.

E3200 E3199 E5043



WELCOME KIT

Suggested Set is not a ready set. Minimum Order Quantity is 100pcs. Items in the box can be replaced with any similar or any item of your choice. There are 4 color options for this: GREEN, BLACK, BLUE AND GRAY.

E31843 E7037 E31983 E20433 E40413



MAG SET

Suggested Set is not a ready set. Minimum Order Quantity is 100pcs. Items in the box can be replaced with any similar or any item of your choice. There are 4 color options for this: GREEN, BLACK, BLUE AND GRAY.

E31392 E31872 E31842 E40412

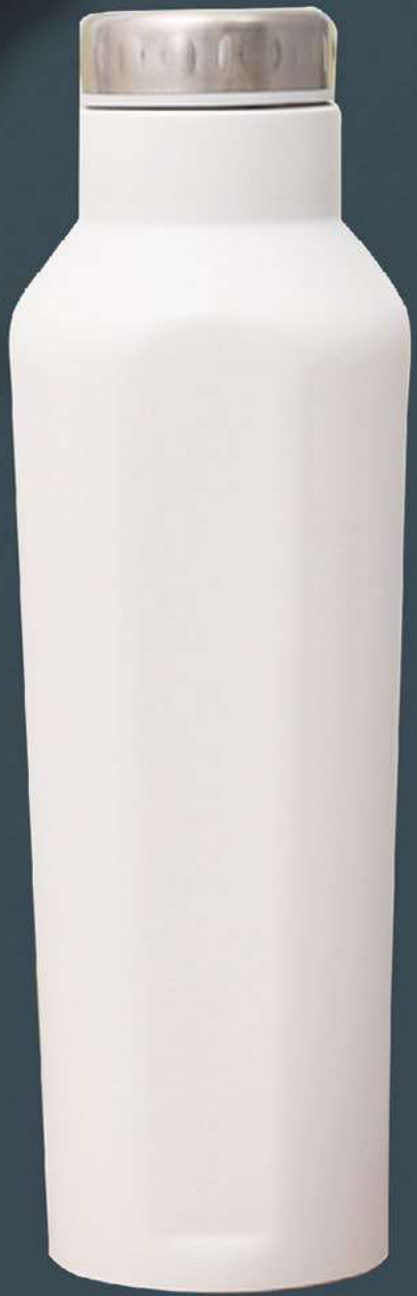

WHITE SET

Suggested Set is not a ready set. Minimum Order Quantity is 100pcs. Items in the box can be replaced with any similar or any item of your choice.

E14070 E70460 E1221 E5046



TECH WHEAT SET

Suggested Set is not a ready set. Minimum Order Quantity is 100pcs. Items in the box can be replaced with any similar or any item of your choice.

E5057 E5060 E5080





NATURAL BAMBOO SET

Suggested Set is not a ready set. Minimum Order Quantity is 100pcs. Items in the box can be replaced with any similar or any item of your choice.

E5057 E5060 E5080



CORK TECH SET

Suggested Set is not a ready set. Minimum Order Quantity is 100pcs. Items in the box can be replaced with any similar or any item of your choice.

E3172 E5067 E1226





VIP SET

Suggested Set is not a ready set. Minimum Order Quantity is 100pcs. Items in the box can be replaced with any similar or any item of your choice.

e31391 E3129 E4036



TECH POUCH

Suggested Set is not a ready set. Minimum Order Quantity is 100pcs. Items in the pouch can be replaced with any similar or any item of your choice.

E31921 E2042 E5073



STYLISH BOX

E1117

Cardboard Gift Box covered in Special PU Material with EVA Foam inside.
Product Size: 22x15.2x2.7cm Packaging: Black Paper Sleeve



White Box

E1317

White hard paper box with white EVA foam inside where you can diecut the items that you want to make a set. Product Size: 17x17x4cm
Packaging: Polybag



SEMI SMALL POUCH E1110

Black pouch with black zipper & metal zipper head, with 2pcs quality elastic inside. With polybag packaging. Dimension: 18x13cm



PU POUCH E1111

Black Pouch PU small with black zipper & metal zipper head, with 2pcs quality elastic inside. Product Size:16x9cm Packaging: Polybag.

SMALL PU POUCH E1112

Black Pouch PU smallest with black zipper & metal zipper head, net on side & 1pc quality elastic on other side. Product Size:13x8cm Packaging: Polybag.





Silver Pouch

E1113

Silver Pouch with zipper with dark grey zipper & metal zipper head, with 2pcs quality elastic inside.
Product Size:16x9cm Packaging: Polybag



Silver Small Pouch

E1114

Silver Pouch with zipper with dark grey zipper & metal zipper head, with 2pcs quality elastic inside.
Product Size:13x8cm Packaging: Polybag



PEN NOT INCLUDED

Pen Tube

E1115

PEN TUBE. High quality transparent pen tube with solid color top and bottom for 1pc pen. Black color. Unit weight: 7.3G Product Size:15.8 cm length Packaging: Polybag



Pen Case

E1116

Black pen bag to fit for 1pc pen. Product Size:16X3cm
Packaging: polybag



**YOUR
CHOICE**



08

YOUR CHOICE

282	283	LANYARD
284	285	CAPS
286	287	NOTEBOOKS
288	289	APARRELS
290	291	GIVAGO
292	294	WELLNESS

CUSTOMIZE

TO BUILD, FIT, OR ALTER ACCORDING TO INDIVIDUAL SPECIFICATIONS.



LOOKING FOR ITEMS WHICH IS NOT AVAILABLE IN OUR CATALOGUE AND IN THE MARKET?
WE CAN DO IT FOR YOU!

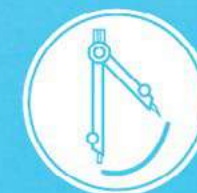

HAS DESIGN OR DETAILS?



QUANTITIES?
ITEM MAY REQUIRE MINIMUM ORDER QUANTITIES



HAS TIME?
CREATING AN ITEM FROM SCRATCH MAY NEED TIME 30-45 DAYS + DELIVERY TIME



THEN WE CAN CUSTOMIZE YOUR REQUIREMENT.

PARTS OF LANYARD



Add your design and logo to the lanyard and select your accessories

MOQ: Depending on material and accessories (100 or 500pcs)

LANYARD

**CHOOSE
YOUR
STYLE**

**CHOOSE
YOUR
MATERIAL**

**CHOOSE
YOUR
COLORS**

Polyester, RPET, Organic
Cotton, Cork, Bamboo

**CHOOSE
YOUR
ACCESSORIES**

Add Safety breakaway
and/or detachable buckle

**CHOOSE
YOUR
BRANDING**

One side or two
side branding



STRUCTURED FRONT PANELS
Fabric laminated for a structured build that maintains shape with a slightly higher crown.



PIPING ON VISOR
Contrast-color piping add an eye-catching look.



SPECIAL FABRIC
Fabrics as Nylon, Microfiber or Rayon, used not only for sportswear and outdoor style, but also for fashionable events.



4 ROWS ON SWEATBAND
Sweatband enhanced by 4 rows on front, closed on back with a taping in matching fabric and colour.



FULL PROSTITCHING
Cap with complete pro-stitching all around the crown.

MOQ:
100pcs



AVAILABLE COLORS

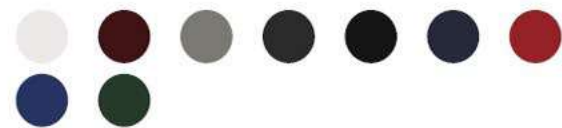

Branding methods
Embroidery, Printing or Heat Transfer

ESTORIL

A 6-panels baseball cap in polyester jacquard fabric, with a contrasting piping on visor and long velcro with plastic buckle at rear



STRUCTURED FRONT PANELS
Fabric laminated for a structured build that maintains shape with a slightly higher crown.



TWILL
Twill is a type of woven textile characterized by diagonal parallel ribs on front.



CURVED VISOR
Our visors are made with a technology that maintains a proper curved shape at all times.



METAL BUCKLE
Adjustable back closure with a metal buckle suitable for any fit.



4 ROWS ON SWEATBAND
Sweatband enhanced by 4 rows on front, closed on back with a taping in matching fabric and colour.



FULL PROSTITCHING
Cap with complete pro-stitching all around the crown.

MOQ:
100pcs



AVAILABLE COLORS



Branding methods
Embroidery, Printing or Heat Transfer

HIT

Comfort, multi-functionality and colour in a well-structured 100% chino cotton twill sports cap, perfect for outdoor activities and practical for every use



STRUCTURED FRONT PANELS
Fabric laminated for a structured build that maintains shape with a slightly higher crown.



TWILL
Twill is a type of woven textile characterized by diagonal parallel ribs on front.



CURVED VISOR
Our visors are made with a technology that maintains a proper curved shape at all times.



METAL BUCKLE
Adjustable back closure with a metal buckle suitable for any fit.



4 ROWS ON SWEATBAND
Sweatband enhanced by 4 rows on front, closed on back with a taping in matching fabric and colour.



FULL PROSTITCHING
Cap with complete pro-stitching all around the crown.

MOQ:
100pcs



AVAILABLE COLORS

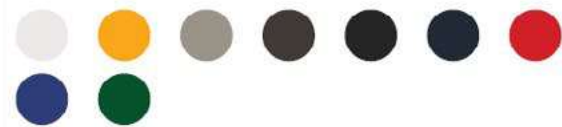

Branding methods
Embroidery, Printing or Heat Transfer

SHOT

The natural and fresh look in a structured five-panel 100% cotton sports cap that gives lightness and comfort for outdoor and everyday activities. Thanks to the wide front crown, Shot is ideal hat for the craziest customizations.



WE CAN MAKE YOUR
**CUSTOMIZED
DESIGN CAPS**
MOQ: 1000PCS



CUSTOMIZED CORPORATE NOTEBOOKS



MOQ:
1000pcs

Unique branding features available for corporate gift notebooks

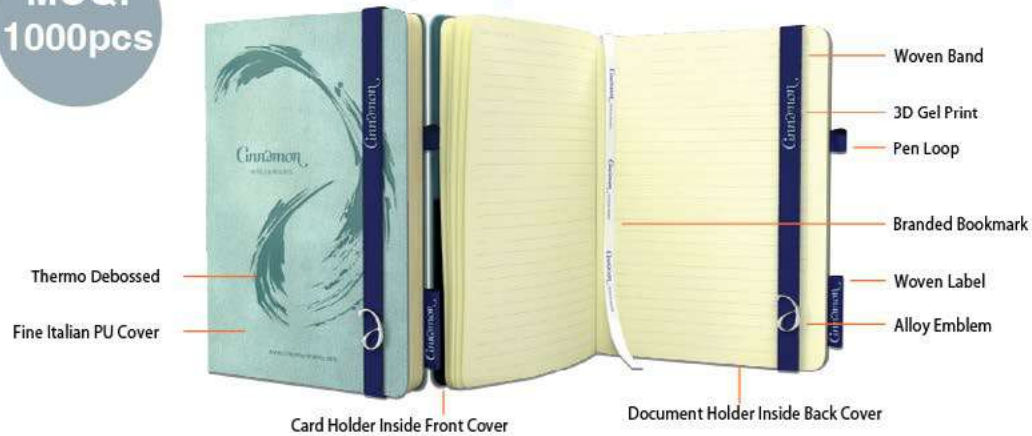

CUSTOMIZED NOTEBOOK

Prestige Collection: A5 size notebook with 192pages of 80GSM cream color acid-free paper. Cover is a thermos sensitive soft-touch or textured PU material. Book block thread sewn and hard case bound or spiral bound with round corner cover.

Optional branding features



Woven elastic band in 1800 full Pantone formula + Multi-colour 3D gel printing.



Brand printing on book mark ribbon.



Movable die-cast or gel-domme alloy metal emblem on woven band.



Woven brand label on open edge of the back cover.



Metal tag on book-mark with laser engraving or screen printing.



Presentation packaging.

In addition to above features, we can provide following customized options:

Customized inside layout. Logo branding on inside pages. Multi colour silk screen printing on the cover. Thermo debossed blocking on full front cover.



- Easy Care
- Wickability
- Breathability
- Softness
- Shape Retention
- Quick Drying
- Total Comfort
- UV Protection

Branding:
Embroidery, Printing,
Heat Transfer

MOQ:
100pcs



SEMI FORMAL



FLEECE HOODIE

MOQ:
100pcs



AVAILABLE IN VARIOUS COLORS



INCENSE BURNER



OIL INCENSE



OTHER COLORS AVAILABLE



PERFUMES



Choose a Perfume Holder and Select the Perfume Scent of your choice that suits your personality and mood.



Loving the scents and want to get a collection?
Gift Sets of 4 and 8 are available.



URBAN SHIELD P-95 MASK (6 LAYER) black

E1338

Reusable and washable outdoor protection mask with 6x Filtration System certified internationally. Has 6 layer protection. Anti-Dust, Anti-Bacterial, Anti-Pollen. Packaging: Polybag



ACTIGUARD MASK (3 LAYER) with Adjustable ear loop

E1339

Reusable and washable outdoor protection mask with adjustable ear loop certified internationally. Has 3 layer protection. Anti-Pollution, Anti-Dust, Anti-Bacterial. Packaging: Paper Pouch

3-LAYER
PROTECTION
MASK

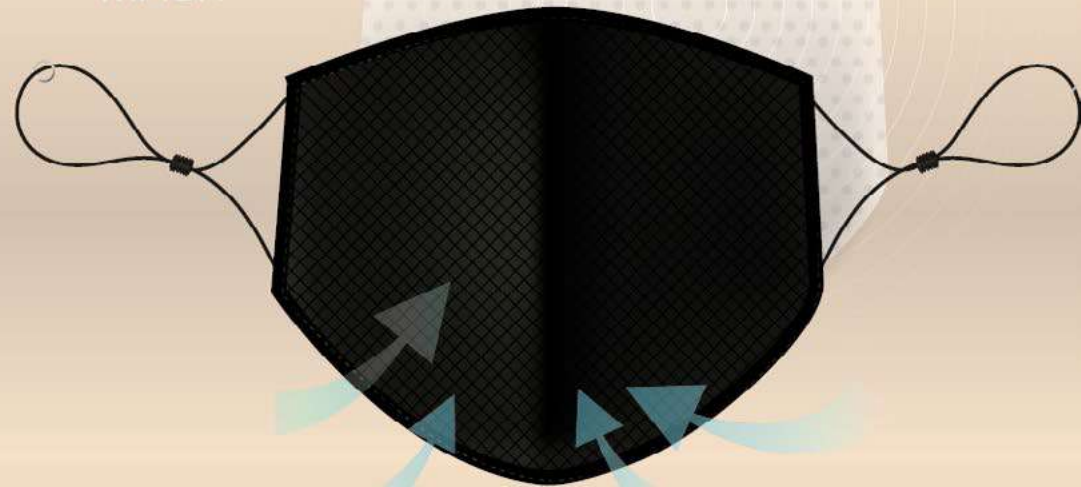

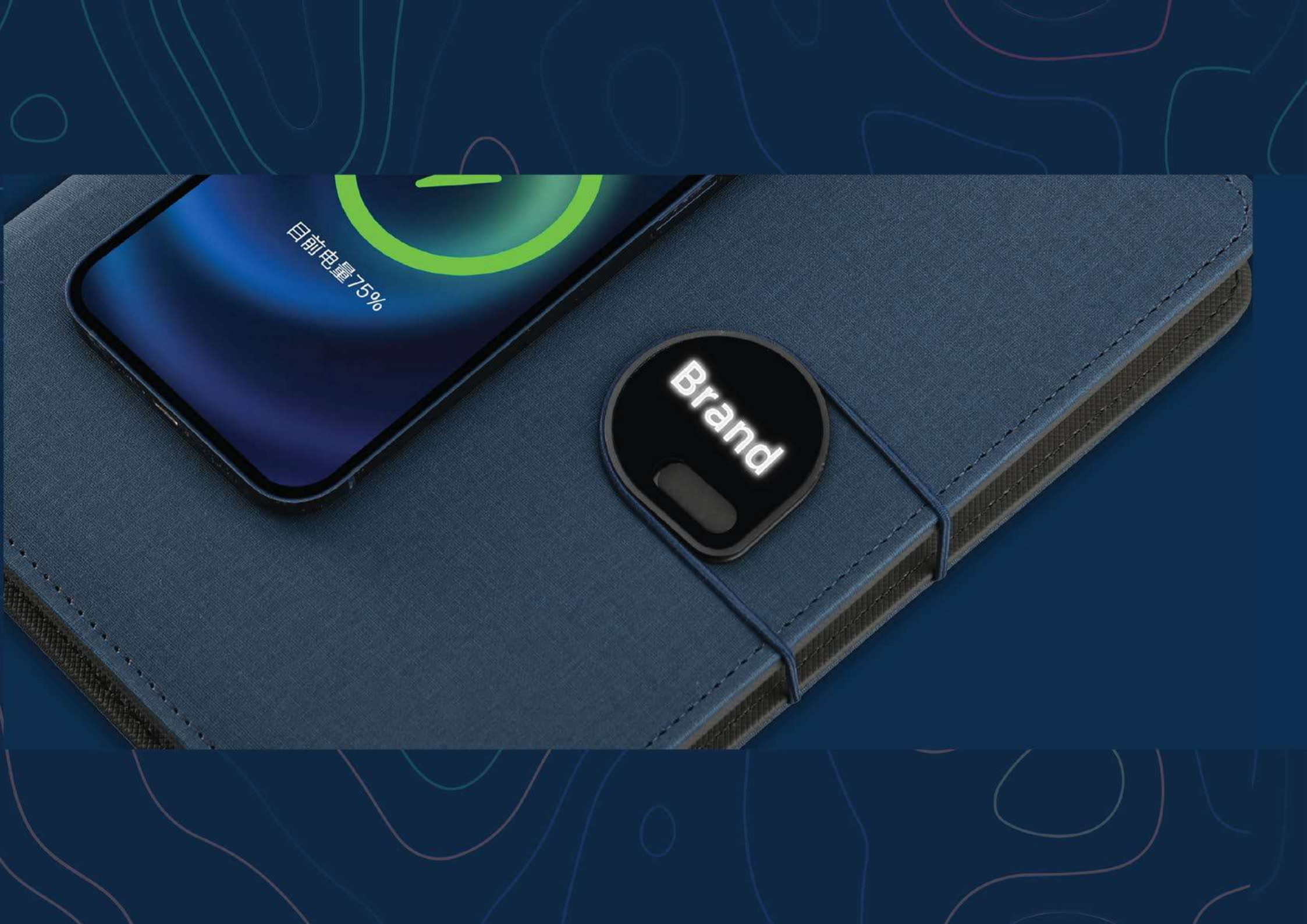

目前电量75%

Brand